

# HMI

## Product Selection Guide



## About Samkoon Technology

Focus on the R&D and manufacturing of automation products,  
and provide complete solutions for Industry 4.0



### Human Machine Interface

- SK Series
- EA Series



### Control Unit

- FAs Series PLC
- FAT Series PLC
- FGR Series MINI PLC
- PRO, MAX Series Bus PLC
- FGs Series Standard PLC
- FGM Series Motion Controller PLC
- GT Series All-in-one



### Drive Element

- R8 Series Servo Driver
- HK Series Servo Motor



## Company Introduction

企

业

# 简介

Quality

Professional

Efficiency

Performance

Shenzhen Samkoon Technology Co., Ltd. (referred to as "Samkoon Technology") was established in March 2007. It is a national high-tech enterprise, a dual-soft enterprise, a "specialized, refined, and new" small and medium-sized enterprise in Shenzhen. The R&D center is located at the High-tech Park, Nanshan District, Shenzhen; and the production base is located at the Fashion Brand Industrial Park of the Shenzhen-Shantou Special Cooperation Zone.

Samkoon Technology has been deeply involved in the field of industrial automation for more than ten years, focusing on the research and development, production and sales of technology and products in the fields of industrial human-machine interface (HMI), programmable logic controller (PLC), servo drives, motion controllers and robots. All software and hardware of products have 100% independent intellectual property rights. At present, Samkoon Technology has accumulatively obtained 72 national patents, including 16 invention patents, 31 software copyrights, 24 utility model patents, and 1 design patent.

## 显控科技







**2007**

Samkoon founded and released 260000 true color LCD HMI series products

**2009**

Honored as "Industrial、Control Research Demonstration Base" by National Sciences and Technology regulatory Commission

**2011**

Awarded as "National High-tech Enterprise"

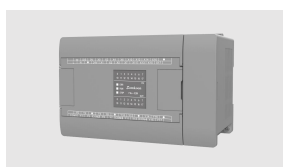

**2012**

Succeeded in the development of Samkoon PLC, and released compiled PLC after three years, which increases 10 times of scanning speed periodically



**2017**

Cooperated with HUST and built research base for postgraduates

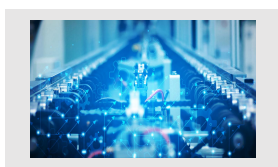

**2017**

Held new product launch in Shenzhen Xilihu Conference Center to announce the dominance of having four core technologies of industrial control

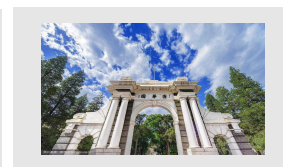

**2018**

Signed cooperative agreement with THU and formally became the practice base for PhD students in automation



**2019**

Built 20000m<sup>2</sup> production plant in Shenzhen-Shanwei cooperation zone, speeding up in industrialization and standardization



**2021**

Samkoon Technology was elected as the governing unit of Shenzhen Advanced Manufacturing Federation



**2022**

Samkoon Technology has been recognized by Shenzhen "specialized, refined and new" small and medium-sized enterprises





## Samkoon industrial automation & digital comprehensive solution

**Industry Solutions:**



Intelligent Manufacturing    Intelligent Vehicle    Intelligent Environmental Protection    Smart Energy    Smart Medical Care    Smart Agriculture    .....

**Samkoon Cloud:**

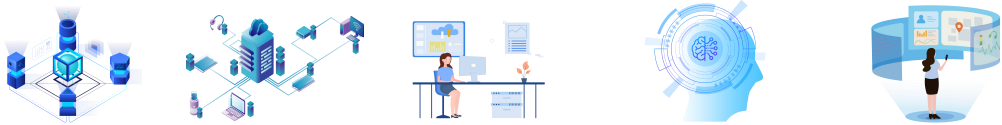

Industrial IoT    Digital Factory    Equipment Operation    Data Empowerment    Data Visualization

**Human-computer interaction layer:**



Waterproof HMI    HD HMI    IoT HMI    Handheld HMI    SK Series HMI    EA Series HMI    Network module

**Control layer:**



FAs Series PLC    FAT Series PLC    All-in-one (HMI+PLC)    PRO Series Bus PLC    FGR Series MINI PLC    FGs Series Standard PLC

**Driver layer:**



R8 Series Servo Driver (Ethercat bus type)    R8 Series Servo Driver (Pulse type)

**Execution/Sensor:**



HK Series Motors    Industrial Robots    Temperature Sensors    Encoders    Solenoid Valves    Temperature Control Meters



# — Contents

<b>SK Series HMI .....</b>	<b>01</b>
IoT HMI.....	02
IoT Extension Module .....	06
Waterproof HMI.....	08
HD HMI.....	10
Handheld HMI.....	12
SK Series Summary.....	14
<b>EA Series HMI.....</b>	<b>32</b>
<b>Optional Accessories .....</b>	<b>37</b>

## SK Series HMI







Samkoon IoT human-machine interface can be quickly connected to the Internet through the dedicated IoT expansion module. The module can be installed on the main body of the human-machine interface through fasteners, which is very convenient to plug and play.

### Product Features

#### Free to choose WIFI/4G networking mode

- According to the combination of the field of use

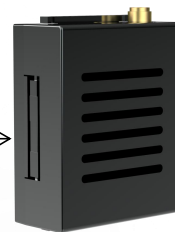

Samkoon IoT expansion module with WIFI mode and 4G mode control cloud platform, plug and play.

## Abundant interfaces and powerful communication capabilities

- Support multiple communication modes (RS232/422/485, Ethernet, WIFI, 4G)
- Support usb download, U disk update configuration

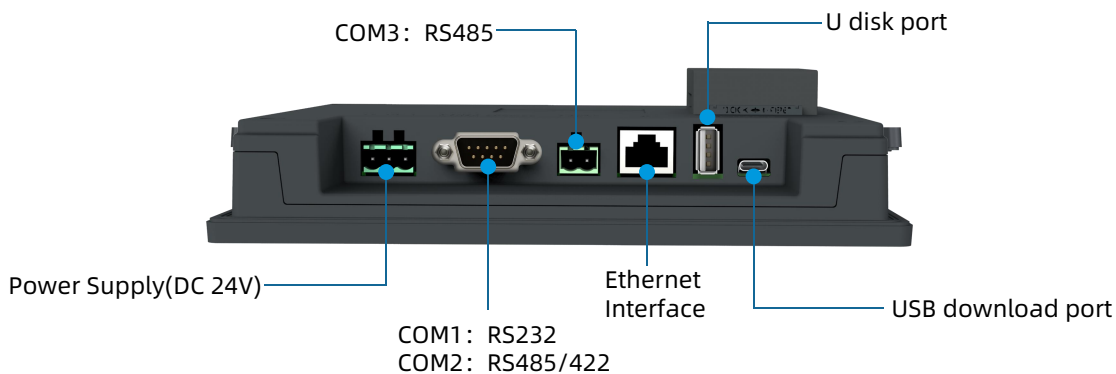

## VNC function

- Support PC and mobile phone to synchronize the data and screen of the human-machine interface, and the user can control the touch screen and monitor the touch screen screen in real time without arriving at the scene
- Support Display Control Cloud 3.0



## Remote transparent transmission

- Support remote downloading of PLC programs, remote monitoring of PLC programs, and solve the troubles that engineers cannot arrive at the scene in time

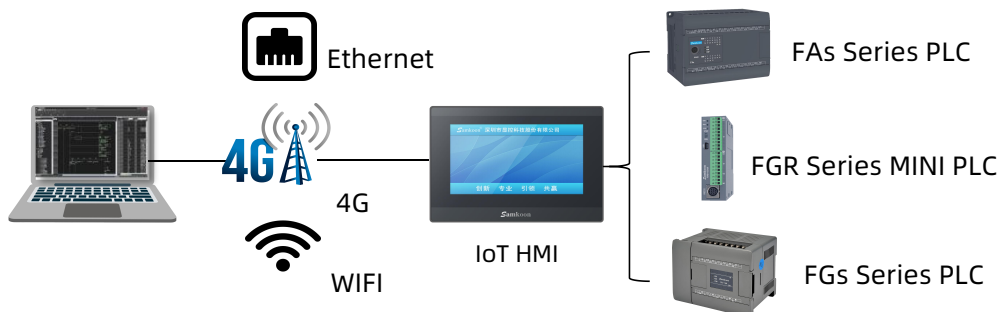

## Product specifications

	Model	SK-070QE-G	SK-070QT-G	SK-070QS-G
Structure and environment	Size(mm)	203 × 145 × 35	203 × 145 × 35	203 × 145 × 35
	Hole size (mm)	192 × 138	192 × 138	192 × 138
	Display size (mm)	7"(16:9)	7"(16:9)	7"(16:9)
	Weight (g)	700	700	700
	Working environment temperature	-20°C~55°C (no freezing)	-20°C~55°C (no freezing)	-20°C~55°C (no freezing)
	Working environment humidity	5~95% (non-condensing)	5~95% (non-condensing)	5~95% (non-condensing)
	Shock resistance	10 ~ 25HZ (XYZ direction 2G/30 minutes)	10 ~ 25HZ (XYZ direction 2G/30 minutes)	10 ~ 25HZ (XYZ direction 2G/30 minutes)
	Shell material	engineering plastic ABS+PC	engineering plastic ABS+PC	engineering plastic ABS+PC
Power supply	Power consumption (W)	4	4	4
	Power supply voltage	(DC12~24V)±15%	(DC12~24V)±15%	(DC12~24V)±15%
	Static level	±6kV	±6kV	±6kV
Display	Resolution (PX)	1024X600	1024X600	1024X600
	Contrast	400:1	400:1	400:1
	Brightness (cd/m²)	450	450	450
	Touch panel	4-wire high precision touch panel	4-wire high precision touch panel	4-wire high precision touch panel
	Display colors	16.77 million	16.77 million	16.77 million
	Backlight Module	LED	LED	LED
Hardware	Storage	128MB DDR3	128MB DDR3	128MB DDR3
	CPU	Cortex A7 1GHz. Dual Core	Cortex A7 1GHz. Dual Core	Cortex A7 1GHz. Dual Core
	RAM	128MB FLASH	128MB FLASH	128MB FLASH
Interface	Network interface	NO	NO	Ethernet
	WIFI	optional	optional	optional
	4G	optional	optional	optional
	USB download port	YES	YES	YES
	U disk port	YES	YES	YES
	Serial interface	COM1 : RS232 COM2 : RS485/422	COM1 : RS232 COM2 : RS485/422	COM1 : RS232 COM2 : RS485/422
	Can interface	NO	NO	NO
	Wiring port	NO	COM3 : RS485	COM3 : RS485
Other parameters	FCC Compatibility	Complies with FCC, Class A	Complies with FCC, Class A	Complies with FCC, Class A
	Withstand voltage test	1000V AC, 1 minute	1000V AC, 1 minute	1000V AC, 1 minute
	CE certification	Complies with EN55032 and EN55035 standards		
	Protection class	IP65 (front panel)	IP65 (front panel)	IP65 (front panel)
	Configuration Software	SKTOOL	SKTOOL	SKTOOL



## Product specifications

Model	SK-102QT-G	SK-102QS-G	
Structure and environment	Size(mm)	273× 211× 40	273× 211× 40
	Hole size (mm)	259× 201	259× 201
	Display size (mm)	10.2"(16:9)	10.2"(16:9)
	Weight (g)	1050	1050
	Working environment temperature	-20°C~55°C (no freezing)	-20°C~55°C (no freezing)
	Working environment humidity	5~95% (non-condensing)	5~95% (non-condensing)
	Shock resistance	10 ~ 25HZ (XYZ direction 2G/30 minutes)	10 ~ 25HZ (XYZ direction 2G/30 minutes)
	Shell material	engineering plastic ABS+PC	engineering plastic ABS+PC
Power supply	Power consumption (W)	7	7
	Power supply voltage	(DC12~24V)±15%	(DC12~24V)±15%
	Static level	±6kV	±6kV
Display	Resolution (PX)	1024 × 600	1024 × 600
	Contrast	400:1	400:1
	Brightness (cd/m <sup>2</sup> )	450	450
	Touch panel	4-wire high precision touch panel	4-wire high precision touch panel
	Display colors	16.77 million	16.77 million
	Backlight Module	LED	LED
Hardware	Resolution (PX)	128MB DDR3	128MB DDR3
	Contrast	Cortex A7 1GHz. Dual Core	Cortex A7 1GHz. Dual Core
	Brightness (cd/m <sup>2</sup> )	128MB FLASH	128MB FLASH
Interface	Network interface	NO	Ethernet
	WIFI	optional	optional
	4G	optional	optional
	USB download port	YES	YES
	U disk port	YES	YES
	Serial interface	COM1:RS232 COM2 :RS485/422 COM3 :RS485	COM1:RS232 COM2 :RS485/422 COM3:RS485
	Can interface	NO	NO
Other parameters	FCC Compatibility	Complies with FCC, Class A	Complies with FCC, Class A
	Withstand voltage test	1000V AC, 1 minute	1000V AC, 1 minute
	CE certification	Complies with EN55032 and EN55035 standards	Complies with EN55032 and EN55035 standards
	Protection class	IP65 (front panel)	IP65 (front panel)
	Configuration Software	SKTOOL	SKTOOL



WIFI module



4G module

### Product Features

- Free to choose WIFI/4G networking mode according to the combination of the field of use
- Support Display Control Cloud 3.0
- The module can be installed on the main body of the human-machine interface through fasteners, realizing fast networking
- Plug and use

### Product specifications

Model		4G module
Hardware parameters	Size(mm)	40.5x55.95x27.5
	Weight (g)	29
	Working environment temperature	-20°C~55°C (no freezing)
	Working environment humidity	5~95% (non-condensing)
	Shock resistance	10 ~ 25HZ (XYZ direction 2G/30 minutes)
	Shell material	engineering plastic ABS+PC
	Networking mode	4G (China Mobile, China Unicom, China Telecom)
	Web video segment	LTE-TDD: B34/B38/B39/B40/B41 LTE-FDD: B1/B3/B5/B8 optional GSM: GSM900/DCS1800
	Re-connecting after network disconnection	YES
	Resume after disconnection	YES
Software parameters	API interface	YES
	VNC function	YES
	Data monitoring	Support up to 280 data points
	Historical data	Support up to 20,000 pieces of data
	Alarm push	Support APP push and WeChat official account push

Product specifications

	Model	WIFI module
Hardware parameters	Size(mm)	40.5x55.95x27.5
	Weight (g)	26
	Working environment temperature	-20°C~55°C (no freezing)
	Working environment humidity	5~95% (non-condensing)
	Shock resistance	10 ~ 25HZ (XYZ direction 2G/30 minutes)
	Shell material	engineering plastic ABS+PC
	Networking mode	WIFI
	Web video segment	IEEE 802.11b, IEEE 802.11g, IEEE 802.11n
	Re-connecting after network disconnection	YES
	Resume after disconnection	YES
Software parameters	API interface	YES
	VNC function	YES
	Data monitoring	Support up to 280 data points
	Historical data	Support up to 20,000 pieces of data
	Alarm push	Support APP push and WeChat official account push

Product Size

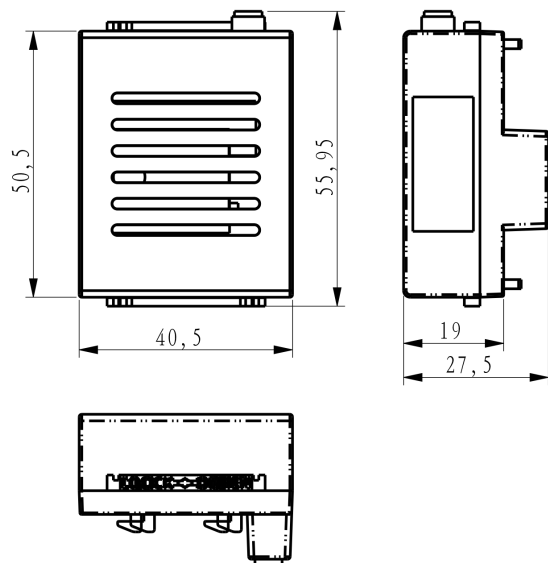





Protection class: IP67(Whole machine)

Designed for harsh industrial environments!

### Product Features

- Based on Linux system, which is stable, efficient, safe and reliable
- Industrial high-performance Cortex A7 processor up to 1GHz.dual core
- Diversified functional modules:multifunctional and control diversification
- Multiple interface embedding: RS485/USB download port/U disk port
- High-standard quality control:Qualified by FCC, ClassA and CE
- Protection class: IP67(Whole machine)

### Exterior structure

#### Blind hole snaps

To prevent water vapor from immersing in the motherboard

#### Waterproof valve

Maintain external pressure balance, isolate water vapor

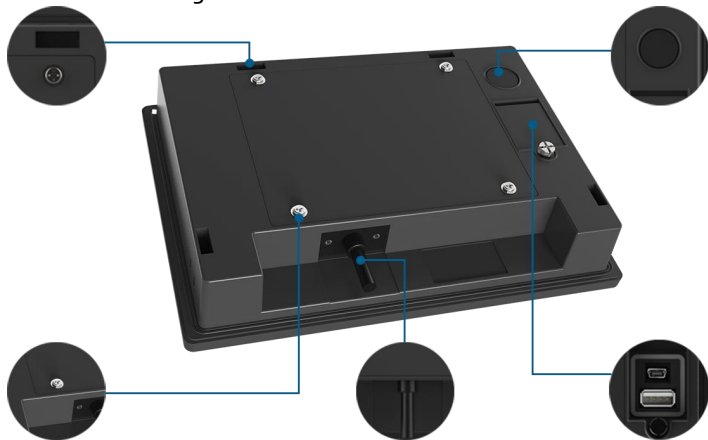

#### Waterproof screws

Corrosion resistance, oxidation resistance, no rust

#### Waterproof power communication connector

To ensure electricity safety

#### Waterproof interface

cover with sealing ring to prevent liquid from entering

## Product specifications

	Model	SK-070QF
Structure and environment	Size(mm)	204 × 148 × 36
	Hole size (mm)	192 × 138
	Display size (mm)	7"(16:9)
	Weight (g)	700
	Working environment temperature	-20°C~55°C (no freezing)
	Working environment humidity	5~95% (non-condensing)
	Shock resistance	10 ~ 25HZ (XYZ direction 2G/30 minutes)
	Shell material	engineering plastic ABS+PC
Power supply	Power consumption (W)	4
	Power supply voltage	(DC12~24V)±15%
	Static level	±6kV
Display	Resolution (PX)	800x480/1024x600
	Contrast	400:1
	Brightness (cd/m <sup>2</sup> )	450
	Touch panel	4-wire high precision touch panel
	Display colors	16.77 million
	Backlight Module	LED
Hardware	Storage	128MB DDR3
	CPU	Cortex A7 1GHz. Dual Core
	RAM	128MB FLASH
Interface	Network interface	NO
	WIFI	NO
	4G	NO
	USB download port	YES
	U disk port	YES
	Serial interface	COM1:RS485
	Can interface	NO
	Wiring port	NO
Other parameters	FCC Compatibility	Complies with FCC, Class A
	Withstand voltage test	1000V AC, 1 minute
	CE certification	Complies with EN55032 and EN55035 standards
	Protection class	IP67(Whole machine)
	Configuration Software	SKTOOL



High-definition highlight

Smooth operation

Visual enjoyment

System stability

Samkoon high-definition human-machine interface screen is more high-definition and brighter. The picture is more refined, allowing users to see the details of each frame of the picture, bringing users more comfortable visual enjoyment, and greatly improving the human-computer interaction experience.

### Product Features

- Based on Linux system, which is stable, efficient, safe and reliable
- Industrial high-performance Cortex A7 processor up to 1GHz.dual core
- High capacity 128MB FLASH+128MB DDR3, support external U disk storage
- Support multiple communication modes (RS232/422/485), Support usb download、U disk update configuration
- Multiple security systems, safe and reliable
- Qualified by FCC, ClassA and CE
- Higher resolution, better picture quality



## Product specifications

	Model	SK-070QH
Structure and environment	Size(mm)	203 × 145 × 35
	Hole size (mm)	192 × 138
	Display size (mm)	7"(16:9)
	Weight (g)	700
	Working environment temperature	-20°C~55°C (no freezing)
	Working environment humidity	5~95% (non-condensing)
	Shock resistance	10 ~ 25HZ (XYZ direction 2G/30 minutes)
	Shell material	engineering plastic ABS+PC
Power supply	Power consumption (W)	4
	Power supply voltage	(DC12~24V)±15%
	Static level	±6kV
Display	Resolution (PX)	1024x600
	Contrast	400:1
	Brightness (cd/m <sup>2</sup> )	450
	Touch panel	4-wire high precision touch panel
	Display colors	16.77 million
	Backlight Module	LED
Hardware	Storage	128MB DDR3
	CPU	Cortex A7 1GHz. Dual Core
	RAM	128MB FLASH
Interface	Network interface	NO
	WIFI	NO
	4G	NO
	USB download port	YES
	U disk port	YES
	Serial interface	COM1:RS232 COM2 :RS485/422
	Can interface	NO
	Wiring port	COM3:RS485
Other parameters	FCC Compatibility	Complies with FCC, Class A
	Withstand voltage test	1000V AC, 1 minute
	CE certification	Complies with EN55032 and EN55035 standards
	Protection class	IP65(front panel)
	Configuration Software	SKTOOL



Samkoon hand-held teaching pendant is specially designed for applications such as industrial robots. The structure conforms to the ergonomic design and can be easily held by one hand or both hands. It is sturdy and durable, with industrial-grade protection and has been widely used in manufacturing and industrial robots and other industries.

### Product Features

- The structure is ergonomically designed, and can be easily held by one hand or both hands
- Industrial grade protection grade, high reliability, durable
- The back has a magnetic suction function, which can be sucked against the machine equipment or control cabinet
- Based on Linux system, which is stable, efficient, safe and reliable
- Industrial high-performance Cortex A8 processor up to 600MHz
- High capacity 256MB FLASH+512MB DDR3, support external U disk storage

### STRUCTURE DESCRIPTION



## Product specifications

	Model	SK-T070XS
Structure and environment	Size(mm)	258x195.4x65.1
	Hole size (mm)	NO
	Display size (mm)	7"(16:9)
	Weight (g)	510
	Working environment temperature	-20°C~55°C (no freezing)
	Working environment humidity	5~95% (non-condensing)
	Shock resistance	10 ~ 25HZ (XYZ direction 2G/30 minutes)
	Shell material	engineering plastic ABS+PC
Power supply	Power consumption (W)	5
	Power supply voltage	(DC12~24V)±15%
	Static level	±6kV
Display	Resolution (PX)	1024x600
	Contrast	400:1
	Brightness (cd/m <sup>2</sup> )	450
	Touch panel	4-wire high precision touch panel
	Display colors	16.77 million
	Backlight Module	LED
Hardware	Storage	512MB DDR3
	CPU	Cortex A8 800MHz
	RAM	256MB FLASH
Interface	Network interface	Ethernet
	WIFI	NO
	4G	NO
	USB download port	YES
	U disk port	YES
	Serial interface	COM1:RS232/485/422
Other parameters	FCC Compatibility	Complies with FCC, Class A
	Withstand voltage test	1000V AC, 1 minute
	CE certification	Complies with EN55032 and EN55035 standards
	Protection class	IP65(front panel)
	Configuration Software	SKTOOL



SK series human-machine interface products have a strong lineup, complete sizes (3.5-15.6 inches full coverage), rich and diverse interfaces (Ethernet port/serial port/USB port), users can choose according to their needs!

### Naming Rules

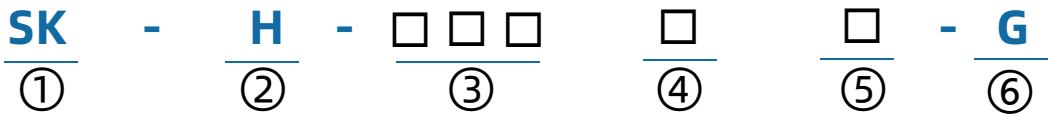

① SK: SK Series HMI

② H: high-performance  
T: hand-held

③ 035: display size 3.5"  
043: display size 4.3"  
050: display size 5.0"  
057: display size 5.7"  
070: display size 7.0"  
102: display size 10.2"  
121: display size 12.1"  
150: display size 15"  
156: display size 15.6"

④ A/B/F/H/C/G/M/X/Q :  
Different hole size  
  
070: A/F/G Same hole size  
070: B/H/M/Q Same hole size

⑤ E: without Ethernet port  
S: with Ethernet port  
G: with 4G module  
D: with Ethernet and can bus  
W: with Wifi module  
T: means with external 485 terminal  
F: means waterproof  
H: means high definition

⑥ G: display IoT HMI

## Product Features

### High-performance configuration

- Based on Linux system, which is stable, efficient, safe and reliable
- Industrial high-performance Cortex A7 processor up to 1GHz. dual core
- High capacity 256MB FLASH+128MB DDR3, support external U disk storage
- Support WIFI/4G/ethernet

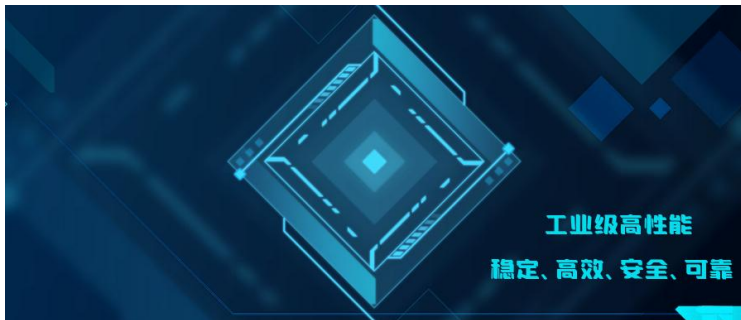

### Multiple interface embedding

- Support multiple communication modes (RS232/422/485, Ethernet, WIFI, 4G)
- Support usb download, ethernet download, U disk update configuration

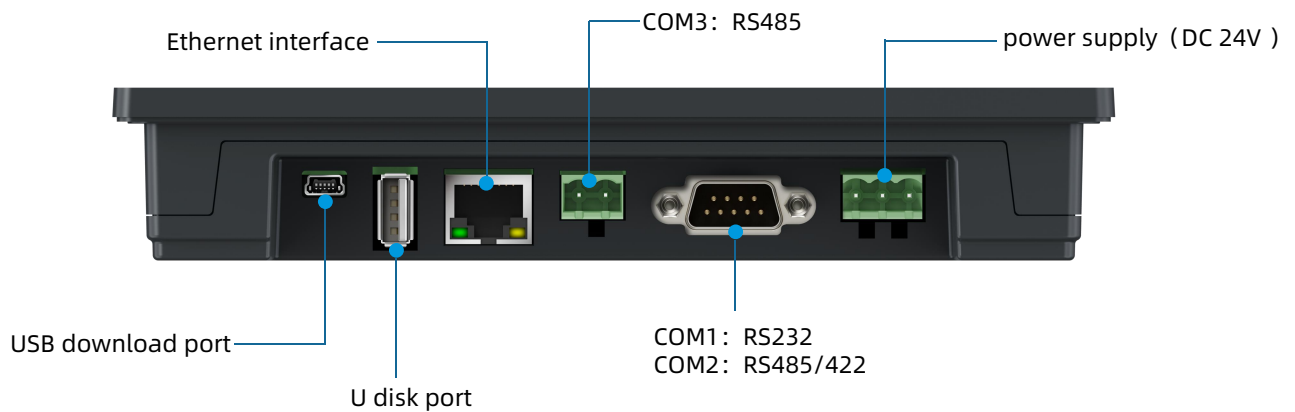





## Brand new code system

- Configuration file encryption

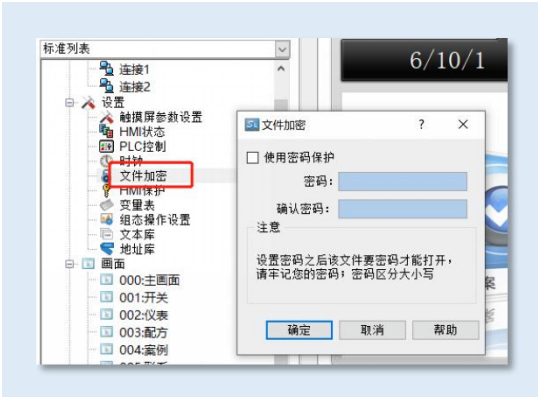

- Multiple security systems, safe and reliable

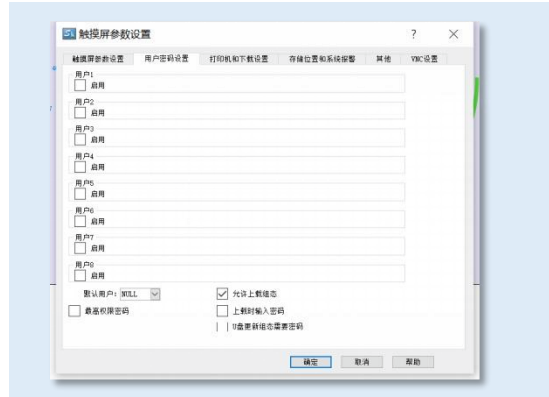

- Installation payment, HMI protection

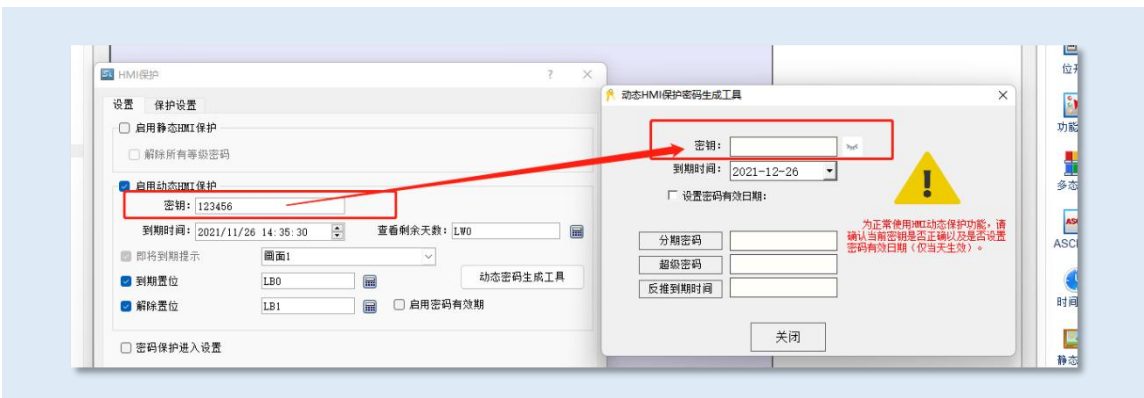

## Abundant choice of color

- 16,770,000 true color display

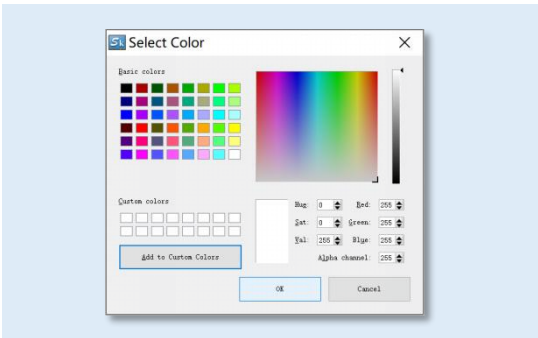

## Strict brand controll

- Qualified by FCC, ClassA and CE

## Product specifications

Model		SK-070QS	SK-070QE	SK-070QT
Structure and environment	Size(mm)	203 × 145 × 35	203 × 145 × 35	203 × 145 × 35
	Hole size (mm)	192 × 138	192 × 138	192 × 138
	Display size (mm)	7"(16:9)	7"(16:9)	7"(16:9)
	Weight (g)	700	700	700
	Working environment temperature	-20°C~55°C (no freezing)	-20°C~55°C (no freezing)	-20°C~55°C (no freezing)
	Working environment humidity	5~95% (non-condensing)	5~95% (non-condensing)	5~95% (non-condensing)
	Shock resistance	10 ~ 25HZ (XYZ direction 2G/30 minutes)	10 ~ 25HZ (XYZ direction 2G/30 minutes)	10 ~ 25HZ (XYZ direction 2G/30 minutes)
	Shell material	engineering plastic ABS+PC	engineering plastic ABS+PC	engineering plastic ABS+PC
Power supply	Power consumption (W)	4	4	4
	Power supply voltage	(DC12~24V)±15%	(DC12~24V)±15%	(DC12~24V)±15%
	Static level	±6kV	±6kV	±6kV
Display	Resolution (PX)	800 × 480	800 × 480	800 × 480
	Contrast	400:1	400:1	400:1
	Brightness (cd/m²)	450	450	450
	Touch panel	4-wire high precision touch panel	4-wire high precision touch panel	4-wire high precision touch panel
	Display colors	16.77 million	16.77 million	16.77 million
	Backlight Module	LED	LED	LED
Hardware	Storage	128MB DDR3	128MB DDR3	128MB DDR3
	CPU	Cortex A7 1GHz. Dual Core	Cortex A7 1GHz. Dual Core	Cortex A7 1GHz. Dual Core
	RAM	128MB FLASH	128MB FLASH	128MB FLASH
Interface	Network interface	Ethernet	NO	NO
	WIFI	NO	NO	NO
	4G	NO	NO	NO
	USB download port	YES	YES	YES
	U disk port	YES	YES	YES
	Serial interface	COM1:RS232 COM2 :RS485/422	COM1:RS232 COM2 :RS485/422	COM1:RS232 COM2 :RS485/422
	Can interface	NO	NO	NO
	Wiring port	COM3:RS485	NO	COM3:RS485
Other parameters	FCC Compatibility	Complies with FCC, Class A	Complies with FCC, Class A	Complies with FCC, Class A
	Withstand voltage test	1000V AC, 1 minute	1000V AC, 1 minute	1000V AC, 1 minute
	CE certification	Complies with EN55032 and EN55035 standards	Complies with EN55032 and EN55035 standards	Complies with EN55032 and EN55035 standards
	Protection class	IP65(front panel)	IP65(front panel)	IP65(front panel)
	Configuration Software	SKTOOL	SKTOOL	SKTOOL

## Product specifications

Model		SK-043QS	SK-043QE	SK-043QT
Structure and environment	Size(mm)	139× 86 × 31	139× 86 × 31	139× 86 × 31
	Hole size (mm)	132 × 80	132 × 80	132 × 80
	Display size (mm)	4.3"(16:9)	4.3"(16:9)	4.3"(16:9)
	Weight (g)	214	200	200
	Working environment temperature	-20°C~55°C (no freezing)	-20°C~55°C (no freezing)	-20°C~55°C (no freezing)
	Working environment humidity	5~95% (non-condensing)	5~95% (non-condensing)	5~95% (non-condensing)
	Shock resistance	10 ~ 25HZ (XYZ direction 2G/30 minutes)	10 ~ 25HZ (XYZ direction 2G/30 minutes)	10 ~ 25HZ (XYZ direction 2G/30 minutes)
	Shell material	engineering plastic ABS+PC	engineering plastic ABS+PC	engineering plastic ABS+PC
Power supply	Power consumption (W)	3	3	3
	Power supply voltage	(DC12~24V)±15%	(DC12~24V)±15%	(DC12~24V)±15%
	Static level	±6kV	±6kV	±6kV
Display	Resolution (PX)	480 × 272	480 × 272	480 × 272
	Contrast	400:1	400:1	400:1
	Brightness (cd/m <sup>2</sup> )	400	400	400
	Touch panel	4-wire high precision touch panel	4-wire high precision touch panel	4-wire high precision touch panel
	Display colors	16.77 million	16.77 million	16.77 million
	Backlight Module	LED	LED	LED
Hardware	Storage	128MB DDR3	128MB DDR3	128MB DDR3
	CPU	Cortex A7 1GHz. Dual Core	Cortex A7 1GHz. Dual Core	Cortex A7 1GHz. Dual Core
	RAM	128MB FLASH	128MB FLASH	128MB FLASH
Interface	Network interface	Ethernet	NO	NO
	WIFI	NO	NO	NO
	4G	NO	NO	NO
	USB download port	YES	YES	YES
	U disk port	YES	YES	YES
	Serial interface	NO	COM1:RS232 COM2 :RS485/422	COM1:RS232 COM2 :RS485/422
	Can interface	NO	NO	NO
	Wiring port	COM1:RS485	NO	COM2 :RS485
Other parameters	FCC Compatibility	Complies with FCC, Class A	Complies with FCC, Class A	Complies with FCC, Class A
	Withstand voltage test	1000V AC, 1 minute	1000V AC, 1 minute	1000V AC, 1 minute
	CE certification	Complies with EN55032 and EN55035 standards	Complies with EN55032 and EN55035 standards	Complies with EN55032 and EN55035 standards
	Protection class	IP65(front panel)	IP65(front panel)	IP65(front panel)
	Configuration Software	SKTOOL	SKTOOL	SKTOOL

Product specifications

Model		SK-102QT	SK-102QS	SK-156QS
Structure and environment	Size(mm)	273× 211× 40	273× 211× 40	395×257×31
	Hole size (mm)	259× 201	259× 201	383×246
	Display size (mm)	10.2"(16:9)	10.2"(16:9)	15.6"(16:9)
	Weight (g)	1050	1050	2450
	Working environment temperature	-20°C~55°C (no freezing)	-20°C~55°C (no freezing)	-20°C~55°C (no freezing)
	Working environment humidity	5~95% (non-condensing)	5~95% (non-condensing)	5~95% (non-condensing)
	Shock resistance	10 ~ 25HZ (XYZ direction 2G/30 minutes)	10 ~ 25HZ (XYZ direction 2G/30 minutes)	10 ~ 25HZ (XYZ direction 2G/30 minutes)
	Shell material	engineering plastic ABS+PC	engineering plastic ABS+PC	engineering plastic ABS+PC
Power supply	Power consumption (W)	7	7	10
	Power supply voltage	(DC12~24V)±15%	(DC12~24V)±15%	(DC12~24V)±15%
	Static level	±6kV	±6kV	±6kV
Display	Resolution (PX)	1024 × 600	1024 × 600	1920×1080
	Contrast	400:1	400:1	700:1
	Brightness (cd/m²)	450	450	300
	Touch panel	4-wire high precision touch pane	4-wire high precision touch pane	4-wire high precision touch pane
	Display colors	16.77 million	16.77 million	16.77 million
	Backlight Module	LED	LED	LED
Hardware	Storage	128MB DDR3	128MB DDR3	256MB DDR3
	CPU	Cortex A7 1GHz. Dual Core	Cortex A7 1GHz. Dual Core	Cortex A7 1GHz. Dual Core
	RAM	128MB FLASH	128MB FLASH	4G (EMMC)
Interface	Network interface	NO	Ethernet	Ethernet
	WIFI	NO	NO	NO
	4G	NO	NO	NO
	USB download port	YES	YES	NO
	U disk port	YES	YES	YES
	Serial interface	COM1:RS232 COM2 :RS485/422 COM3 :RS485	COM1:RS232 COM2 :RS485/422 COM3:RS485	COM1 :RS232/422/485 COM2:RS485
	Can interface	NO	NO	NO
	Wiring port	NO	NO	NO
Other parameters	FCC Compatibility	Complies with FCC, Class A	Complies with FCC, Class A	Complies with FCC, Class A
	Withstand voltage test	1000V AC, 1 minute	1000V AC, 1 minute	1000V AC, 1 minute
	CE certification	Complies with EN55032 and EN55035 standards	Complies with EN55032 and EN55035 standards	Complies with EN55032 and EN55035 standards
	Protection class	IP65(front panel)	IP65(front panel)	IP65(front panel)
	Configuration Software	SKTOOL	SKTOOL	SKTOOL

## Product specifications

Model		SK-035FE	SK-035UE	SK-043UE	SK-043FE
Structure and environment	Size(mm)	135 × 89 × 39	96 × 81 × 47	138 × 86 × 38	150 × 93 × 39
	Hole size (mm)	123 × 80	92 × 77	132 × 80	141 × 84
	Display size (mm)	3.5"(4:3)	3.5"(4:3)	4.3"(16:9)	4.3"(16:9)
	Weight (g)	200	200	200	270
	Working environment temperature	-20°C~55°C (no freezing)	-20°C~55°C (no freezing)	-20°C~55°C (no freezing)	-20°C~55°C (no freezing)
	Working environment humidity	5~95% (non-condensing)	5~95% (non-condensing)	5~95% (non-condensing)	5~95% (non-condensing)
	Shock resistance	10 ~ 25HZ (XYZ direction 2G/30 minutes)	10 ~ 25HZ (XYZ direction 2G/30 minutes)	10 ~ 25HZ (XYZ direction 2G/30 minutes)	10 ~ 25HZ (XYZ direction 2G/30 minutes)
	Shell material	engineering plastic ABS+PC	engineering plastic ABS+PC	engineering plastic ABS+PC	engineering plastic ABS+PC
Power supply	Power consumption (W)	3	3	3	3
	Power supply voltage	(DC12~24V)±15%	(DC12~24V)±15%	(DC12~24V)±15%	(DC12~24V)±15%
	Static level	±6kV	±6kV	±6kV	±6kV
Display	Resolution (PX)	320 × 240	320 × 240	480 × 272	480 × 272
	Contrast	400:1	400:1	400:1	400:1
	Brightness (cd/m <sup>2</sup> )	350	350	400	400
	Touch panel	4-wire high precision touch pane	4-wire high precision touch pane	4-wire high precision touch pane	4-wire high precision touch pane
	Display colors	16.77 million	16.77 million	16.77 million	16.77 million
	Backlight Module	LED	LED	LED	LED
Hardware	Storage	128MB DDR3	128MB DDR3	128MB DDR3	128MB DDR3
	CPU	Cortex A8 600MHz	Cortex A8 600MHz	Cortex A8 600MHz	Cortex A7 1GHz. Dual Core
	RAM	128MB FLASH	128MB FLASH	128MB FLASH	128MB FLASH
Interface	Network interface	NO	NO	NO	NO
	WIFI	NO	NO	NO	NO
	4G	NO	NO	NO	NO
	USB download port	YES	YES	YES	YES
	U disk port	NO	NO	NO	YES
	Wiring port	COM:RS232/422/485	COM:RS232/422/485	COM:RS232/422/485	COM:RS232/422/485
Other parameters	FCC Compatibility	Complies with FCC, Class A	Complies with FCC, Class A	Complies with FCC, Class A	Complies with FCC, Class A
	Withstand voltage test	1000V AC, 1 minute	1000V AC, 1 minute	1000V AC, 1 minute	1000V AC, 1 minute
	CE certification	Complies with EN55032 and EN55035 standards	Complies with EN55032 and EN55035 standards	Complies with EN55032 and EN55035 standards	Complies with EN55032 and EN55035 standards
	Protection class	IP65(front panel)	IP65(front panel)	IP65(front panel)	IP65(front panel)
	Configuration Software	SKTOOL	SKTOOL	SKTOOL	SKTOOL

## Product specifications

Model		SK-043HE	SK-043HS	SK-057FE	SK-050HE
Structure and environment	Size(mm)	173 × 95 × 39	173 × 95 × 39	177 × 140 × 40	165 × 103 × 39
	Hole size (mm)	163 × 85	163 × 85	163 × 133	157 × 95
	Display size (mm)	4.3"(16:9)	4.3"(16:9)	5.7"(4:3)	5"(16:9)
	Weight (g)	270g	270g	510g	330g
	Working environment temperature	-20°C~55°C (no freezing)	-20°C~55°C (no freezing)	-20°C~55°C (no freezing)	-20°C~55°C (no freezing)
	Working environment humidity	5~95% (non-condensing)	5~95% (non-condensing)	5~95% (non-condensing)	5~95% (non-condensing)
	Shock resistance	10 ~ 25HZ (XYZ direction 2G/30 minutes)	10 ~ 25HZ (XYZ direction 2G/30 minutes)	10 ~ 25HZ (XYZ direction 2G/30 minutes)	10 ~ 25HZ (XYZ direction 2G/30 minutes)
	Shell material	engineering plastic ABS+PC	engineering plastic ABS+PC	engineering plastic ABS+PC	engineering plastic ABS+PC
Power supply	Power consumption (W)	3	3	5	4
	Power supply voltage	(DC12~24V)±15%	(DC12~24V)±15%	(DC12~24V)±15%	(DC12~24V)±15%
	Static level	±6kV	±6kV	±6kV	±6kV
Display	Resolution (PX)	480 × 272	480 × 272	640 × 480	800 × 480
	Contrast	400:1	400:1	400:1	400:1
	Brightness (cd/m²)	400	400	400	400
	Touch panel	4-wire high precision touch pane	4-wire high precision touch pane	4-wire high precision touch pane	4-wire high precision touch pane
	Display colors	16.77 million	16.77 million	16.77 million	16.77 million
	Backlight Module	LED	LED	LED	LED
Hardware	Storage	128MB DDR3	128MB DDR3	128MB DDR3	128MB DDR3
	CPU	Cortex A7 1GHz. Dual Core	Cortex A7 1GHz. Dual Core	Cortex A7 1GHz. Dual Core	Cortex A7 1GHz. Dual Core
	RAM	128MB FLASH	128MB FLASH	128MB FLASH	128MB FLASH
Interface	Network interface	NO	Ethernet	NO	NO
	WIFI	NO	NO	NO	NO
	4G	NO	NO	NO	NO
	USB download port	YES	YES	YES	YES
	U disk port	YES	YES	YES	YES
	Wiring port	COM:RS232/422/485	COM:RS232/422/485	COM1 COM2: RS232/422/485	COM:RS232/422/485
Other parameters	FCC Compatibility	Complies with FCC, Class A	Complies with FCC, Class A	Complies with FCC, Class A	Complies with FCC, Class A
	Withstand voltage test	1000V AC, 1 minute	1000V AC, 1 minute	1000V AC, 1 minute	1000V AC, 1 minute
	CE certification	Complies with EN55032 and EN55035 standards	Complies with EN55032 and EN55035 standards	Complies with EN55032 and EN55035 standards	Complies with EN55032 and EN55035 standards
	Protection class	IP65(front panel)	IP65(front panel)	IP65(front panel)	IP65(front panel)
	Configuration Software	SKTOOL	SKTOOL	SKTOOL	SKTOOL



## Product specifications

Model		SK-050HS	SK-070GE	SK-070GS	SK-070GG
Structure and environment	Size(mm)	165 × 103 × 39	225 × 153 × 40	225 × 153 × 40	225 × 153 × 40
	Hole size (mm)	157 × 95	210 × 144	210 × 144	210 × 144
	Display size (mm)	5"(16:9)	7"(16:9)	7"(16:9)	7"(16:9)
	Weight (g)	330	700	700	700
	Working environment temperature	-20°C~55°C (no freezing)	-20°C~55°C (no freezing)	-20°C~55°C (no freezing)	-20°C~55°C (no freezing)
	Working environment humidity	5~95% (non-condensing)	5~95% (non-condensing)	5~95% (non-condensing)	5~95% (non-condensing)
	Shock resistance	10 ~ 25HZ (XYZ direction 2G/30 minutes)	10 ~ 25HZ (XYZ direction 2G/30 minutes)	10 ~ 25HZ (XYZ direction 2G/30 minutes)	10 ~ 25HZ (XYZ direction 2G/30 minutes)
	Shell material	engineering plastic ABS+PC	engineering plastic ABS+PC	engineering plastic ABS+PC	engineering plastic ABS+PC
Power supply	Power consumption (W)	4	5	5	5
	Power supply voltage	(DC12~24V)±15%	(DC12~24V)±15%	(DC12~24V)±15%	(DC12~24V)±15%
	Static level	±6kV	±6kV	±6kV	±6kV
Display	Resolution (PX)	800 × 480	800 × 480	800 × 480	800 × 480
	Contrast	400:1	400:1	400:1	400:1
	Brightness (cd/m²)	400	450	450	450
	Touch panel	4-wire high precision touch pane	4-wire high precision touch pane	4-wire high precision touch pane	4-wire high precision touch pane
	Display colors	16.77 million	16.77 million	16.77 million	16.77 million
Backlight Module	LED	LED	LED	LED	
Hardware	Storage	128MB DDR3	128MB DDR3	128MB DDR3	128MB DDR3
	CPU	Cortex A7 1GHz. Dual Core	Cortex A7 1GHz. Dual Core	Cortex A7 1GHz. Dual Core	Cortex A8 600MHz
	RAM	128MB FLASH	128MB FLASH	128MB FLASH	256MB FLASH
Interface	Network interface	Ethernet	NO	Ethernet	Ethernet
	WIFI	NO	NO	NO	NO
	4G	NO	NO	NO	YES
	USB download port	YES	YES	YES	YES
	U disk port	YES	YES	YES	YES
	Wiring port	COM:RS232/422/485	COM1 COM2: RS232/422/485	COM1 COM2: RS232/422/485	COM1 COM2: RS232/422/485
	Can interface	NO	NO	NO	YES
Other parameters	FCC Compatibility	Complies with FCC, Class A	Complies with FCC, Class A	Complies with FCC, Class A	Complies with FCC, Class A
	Withstand voltage test	1000V AC, 1 minute	1000V AC, 1 minute	1000V AC, 1 minute	1000V AC, 1 minute
	CE certification	Complies with EN55032 and EN55035 standards	Complies with EN55032 and EN55035 standards	Complies with EN55032 and EN55035 standards	Complies with EN55032 and EN55035 standards
	Protection class	IP65(front panel)	IP65(front panel)	IP65(front panel)	IP65(front panel)
	Configuration Software	SKTOOL	SKTOOL	SKTOOL	SKTOOL

Product specifications

Model	SK-070GW	SK-070ME	SK-070MS	SK-070MG	
Structure and environment	Size(mm)	25 × 153 × 40	205 × 145 × 40	205 × 145 × 40	205 × 145 × 40
	Hole size (mm)	210 × 144	192 × 138	192 × 138	192 × 138
	Display size (mm)	7"(16:9)	7"(16:9)	7"(16:9)	7"(16:9)
	Weight (g)	700	700	700	700
	Working environment temperature	-20°C~55°C (no freezing)	-20°C~55°C (no freezing)	-20°C~55°C (no freezing)	-20°C~55°C (no freezing)
	Working environment humidity	5~95% (non-condensing)	5~95% (non-condensing)	5~95% (non-condensing)	5~95% (non-condensing)
	Shock resistance	10 ~ 25HZ (XYZ direction 2G/30 minutes)	10 ~ 25HZ (XYZ direction 2G/30 minutes)	10 ~ 25HZ (XYZ direction 2G/30 minutes)	10 ~ 25HZ (XYZ direction 2G/30 minutes)
	Shell material	engineering plastic ABS+PC	engineering plastic ABS+PC	engineering plastic ABS+PC	engineering plastic ABS+PC
Power supply	Power consumption (W)	5	5	5	5
	Power supply voltage	(DC12~24V)±15%	(DC12~24V)±15%	(DC12~24V)±15%	(DC12~24V)±15%
	Static level	±6kV	±6kV	±6kV	±6kV
Display	Resolution (PX)	800 × 480	800 × 480	800 × 480	800 × 480
	Contrast	400:1	400:1	400:1	400:1
	Brightness (cd/m <sup>2</sup> )	450	450	450	450
	Touch panel	4-wire high precision touch pane	4-wire high precision touch pane	4-wire high precision touch pane	4-wire high precision touch pane
	Display colors	16.77 million	16.77 million	16.77 million	16.77 million
	Backlight Module	LED	LED	LED	LED
Hardware	Storage	128MB DDR3	128MB DDR3	128MB DDR3	128MB DDR3
	CPU	Cortex A8 600MHz	Cortex A8 600MHz	Cortex A8 600MHz	Cortex A8 600MHz
	RAM	256MB FLASH	128MB FLASH	128MB FLASH	256MB FLASH
Interface	Network interface	Ethernet	NO	Ethernet	Ethernet
	WIFI	YES	NO	NO	NO
	4G	NO	NO	NO	YES
	USB download port	YES	YES	YES	YES
	U disk port	YES	YES	YES	YES
	Wiring port	COM1 COM2: RS232/422/485	COM1 COM2: RS232/422/485	COM1 COM2: RS232/422/485	COM1 COM2: RS232/422/485
	Can interface	YES	NO	NO	YES
Other parameters	FCC Compatibility	Complies with FCC, Class A	Complies with FCC, Class A	Complies with FCC, Class A	Complies with FCC, Class A
	Withstand voltage test	1000V AC, 1 minute	1000V AC, 1 minute	1000V AC, 1 minute	1000V AC, 1 minute
	CE certification	Complies with EN55032 and EN55035 standards	Complies with EN55032 and EN55035 standards	Complies with EN55032 and EN55035 standards	Complies with EN55032 and EN55035 standards
	Protection class	IP65(front panel)	IP65(front panel)	IP65(front panel)	IP65(front panel)
	Configuration Software	SKTOOL	SKTOOL	SKTOOL	SKTOOL

## Product specifications

Model		SK-070MW	SK-102CE	SK-102CS	SK-102CG
Structure and environment	Size(mm)	205 × 145 × 40	274 × 180 × 40	274 × 180 × 40	274 × 180 × 40
	Hole size (mm)	192 × 138	255 × 167	255 × 167	255 × 167
	Display size (mm)	7"(16:9)	10.2"(16:9)	10.2"(16:9)	10.2"(16:9)
	Weight (g)	700	1000	1000	1000
	Working environment temperature	-20°C~55°C (no freezing)	-20°C~55°C (no freezing)	-20°C~55°C (no freezing)	-20°C~55°C (no freezing)
	Working environment humidity	5~95% (non-condensing)	5~95% (non-condensing)	5~95% (non-condensing)	5~95% (non-condensing)
	Shock resistance	10 ~ 25HZ (XYZ direction 2G/30 minutes)	10 ~ 25HZ (XYZ direction 2G/30 minutes)	10 ~ 25HZ (XYZ direction 2G/30 minutes)	10 ~ 25HZ (XYZ direction 2G/30 minutes)
	Shell material	engineering plastic ABS+PC	engineering plastic ABS+PC	engineering plastic ABS+PC	engineering plastic ABS+PC
Power supply	Power consumption (W)	5	7	7	7
	Power supply voltage	(DC12~24V)±15%	(DC12~24V)±15%	(DC12~24V)±15%	(DC12~24V)±15%
	Static level	±6kV	±6kV	±6kV	±6kV
Display	Resolution (PX)	800 × 480	1024 × 600	1024 × 600	1024 × 600
	Contrast	400:1	450:1	450:1	450:1
	Brightness (cd/m <sup>2</sup> )	450	500	500	500
	Touch panel	4-wire high precision touch pane	4-wire high precision touch pane	4-wire high precision touch pane	4-wire high precision touch pane
	Display colors	16.77 million	16.77 million	16.77 million	16.77 million
Backlight Module	LED	LED	LED	LED	
Hardware	Storage	128MB DDR3	128MB DDR3	128MB DDR3	128MB DDR3
	CPU	Cortex A8 600MHz	Cortex A7 1GHz. Dual Core	Cortex A7 1GHz. Dual Core	Cortex A8 600MHz
	RAM	256MB FLASH	128MB FLASH	128 MB FLASH	256MB FLASH
Interface	Network interface	Ethernet	NO	Ethernet	Ethernet
	WIFI	YES	NO	NO	NO
	4G	NO	NO	NO	YES
	USB download port	YES	YES	YES	YES
	U disk port	YES	YES	YES	YES
	Wiring port	COM1 COM2: RS232/422/485	COM1 COM2: RS232/422/485	COM1 COM2: RS232/422/485	COM1 COM2: RS232/422/485
	Can interface	YES	NO	NO	YES
Other parameters	FCC Compatibility	Complies with FCC, Class A	Complies with FCC, Class A	Complies with FCC, Class A	Complies with FCC, Class A
	Withstand voltage test	1000V AC, 1 minute	1000V AC, 1 minute	1000V AC, 1 minute	1000V AC, 1 minute
	CE certification	Complies with EN55032 and EN55035 standards	Complies with EN55032 and EN55035 standards	Complies with EN55032 and EN55035 standards	Complies with EN55032 and EN55035 standards
	Protection class	IP65(front panel)	IP65(front panel)	IP65(front panel)	IP65(front panel)
	Configuration Software	SKTOOL	SKTOOL	SKTOOL	SKTOOL

## Product specifications

	Model	SK-102CW	SK-102HE	SK-102HS	SK-102HG
Structure and environment	Size(mm)	274 × 180 × 40	275 × 211 × 44	275 × 211 × 44	275 × 211 × 44
	Hole size (mm)	255 × 167	259 × 201	259 × 201	259 × 201
	Display size (mm)	10.2"(16:9)	10.2"(16:9)	10.2"(16:9)	10.2"(16:9)
	Weight (g)	1000	1050	1050	1050
	Working environment temperature	-20°C~55°C (no freezing)	-20°C~55°C (no freezing)	-20°C~55°C (no freezing)	-20°C~55°C (no freezing)
	Working environment humidity	5~95% (non-condensing)	5~95% (non-condensing)	5~95% (non-condensing)	5~95% (non-condensing)
	Shock resistance	10 ~ 25HZ (XYZ direction 2G/30 minutes)	10 ~ 25HZ (XYZ direction 2G/30 minutes)	10 ~ 25HZ (XYZ direction 2G/30 minutes)	10 ~ 25HZ (XYZ direction 2G/30 minutes)
	Shell material	engineering plastic ABS+PC	engineering plastic ABS+PC	engineering plastic ABS+PC	engineering plastic ABS+PC
Power supply	Power consumption (W)	7	7	7	7
	Power supply voltage	(DC12~24V)±15%	(DC12~24V)±15%	(DC12~24V)±15%	(DC12~24V)±15%
	Static level	±6kV	±6kV	±6kV	±6kV
Display	Resolution (PX)	1024 × 600	1024 × 600	1024 × 600	1024 × 600
	Contrast	450:1	450:1	450:1	450:1
	Brightness (cd/m²)	500	500	500	500
	Touch panel	4-wire high precision touch pane	4-wire high precision touch pane	4-wire high precision touch pane	4-wire high precision touch pane
	Display colors	16.77 million	16.77 million	16.77 million	16.77 million
	Backlight Module	LED	LED	LED	LED
Hardware	Storage	128MB DDR3	128MB DDR3	128MB DDR3	128MB DDR3
	CPU	Cortex A8 600MHZ	Cortex A8 600MHZ	Cortex A8 600MHZ	Cortex A8 600MHZ
	RAM	256MB FLASH	128MB FLASH	128 MB FLASH	256MB FLASH
Interface	Network interface	Ethernet	NO	Ethernet	Ethernet
	WIFI	YES	NO	NO	NO
	4G	NO	NO	NO	YES
	USB download port	YES	YES	YES	YES
	U disk port	YES	YES	YES	YES
	Wiring port	COM1 COM2: RS232/422/485	COM1 COM2: RS232/422/485	COM1 COM2: RS232/422/485	COM1 COM2: RS232/422/485
	Can interface	YES	NO	NO	YES
Other parameters	FCC Compatibility	Complies with FCC, Class A	Complies with FCC, Class A	Complies with FCC, Class A	Complies with FCC, Class A
	Withstand voltage test	1000V AC, 1 minute	1000V AC, 1 minute	1000V AC, 1 minute	1000V AC, 1 minute
	CE certification	Complies with EN55032 and EN55035 standards	Complies with EN55032 and EN55035 standards	Complies with EN55032 and EN55035 standards	Complies with EN55032 and EN55035 standards
	Protection class	IP65(front panel)	IP65(front panel)	IP65(front panel)	IP65(front panel)
	Configuration Software	SKTOOL	SKTOOL	SKTOOL	SKTOOL

## Product specifications

	Model	SK-102HW	SK-H150AS	SK-070ME(v3.0)	SK-070MS(v3.0)
Structure and environment	Size(mm)	275 × 211 × 44	365 × 302 × 63	205 × 145 × 40	205 × 145 × 40
	Hole size (mm)	259 × 201	356 × 293	192 × 138	192 × 138
	Display size (mm)	10.2"(16:9)	15"(4:3)	7"(16:9)	7"(16:9)
	Weight (g)	1050	3000	700	700
	Working environment temperature	-20°C~55°C (no freezing)	-20°C~55°C (no freezing)	-20°C~55°C (no freezing)	-20°C~55°C (no freezing)
	Working environment humidity	5~95% (non-condensing)	5~95% (non-condensing)	5~95% (non-condensing)	5~95% (non-condensing)
	Shock resistance	10 ~ 25HZ (XYZ direction 2G/30 minutes)	10 ~ 25HZ (XYZ direction 2G/30 minutes)	10 ~ 25HZ (XYZ direction 2G/30 minutes)	10 ~ 25HZ (XYZ direction 2G/30 minutes)
	Shell material	engineering plastic ABS+PC	engineering plastic ABS+PC	engineering plastic ABS+PC	engineering plastic ABS+PC
Power supply	Power consumption (W)	7	10	5	5
	Power supply voltage	(DC12~24V)±15%	(DC12~24V)±15%	(DC12~24V)±15%	(DC12~24V)±15%
	Static level	±6kV	±6kV	±6kV	±6kV
Display	Resolution (PX)	1024 × 600	1024 × 768	800 × 480	800 × 480
	Contrast	450:1	500:1	400:1	400:1
	Brightness (cd/m <sup>2</sup> )	500	500	450	450
	Touch panel	4-wire high precision touch pane	4-wire high precision touch pane	4-wire high precision touch pane	4-wire high precision touch pane
	Display colors	16.77 million	16.77 million	16.77 million	16.77 million
Backlight Module	LED	LED	LED	LED	
Hardware	Storage	128MB DDR3	2GB DDR3	128MB DDR3	128MB DDR3
	CPU	Cortex A8 600MHz	4 nuclear Cortex A17 1.5GHz.	Cortex A8 600MHz	Cortex A8 600MHz
	RAM	256MB FLASH	8G	128 MB FLASH	128 MB FLASH
Interface	Network interface	Ethernet	Ethernet	NO	Ethernet
	WIFI	YES	NO	NO	NO
	4G	NO	NO	NO	NO
	USB download port	YES	YES	YES	YES
	U disk port	YES	YES	YES	YES
	Wiring port	COM1 COM2: RS232/422/485	COM1 COM2: RS232/422/485	COM1 :RS232/422/485 COM2:RS485 (Optional)	COM1 :RS232/422/485 COM2:RS485 (Optional)
	Can interface	YES	NO	NO	NO
Other parameters	FCC Compatibility	Complies with FCC, Class A	Complies with FCC, Class A	Complies with FCC, Class A	Complies with FCC, Class A
	Withstand voltage test	1000V AC, 1 minute	1000V AC, 1 minute	1000V AC, 1 minute	1000V AC, 1 minute
	CE certification	Complies with EN55032 and EN55035 standards	Complies with EN55032 and EN55035 standards	Complies with EN55032 and EN55035 standards	Complies with EN55032 and EN55035 standards
	Protection class	IP65(front panel)	IP65(front panel)	IP65(front panel)	IP65(front panel)
	Configuration Software	SKTOOL	SKTOOL	SKTOOL	SKTOOL

## Product specifications

Model	SK-102HE(v3.0)	SK-102HS(v3.0)	SK-121FE	SK-121FS	
Structure and environment	Size(mm)	273 × 211 × 39	273 × 211 × 39	340 × 256 × 54	340 × 256 × 54
	Hole size (mm)	259 × 201	259 × 201	330 × 246	330 × 246
	Display size (mm)	10.2"(16:9)	10.2"(16:9)	12.1"(4:3)	12.1"(4:3)
	Weight (g)	1050	1050	2160	2160
	Working environment temperature	-20°C~55°C (no freezing)	-20°C~55°C (no freezing)	-20°C~55°C (no freezing)	-20°C~55°C (no freezing)
	Working environment humidity	5~95% (non-condensing)	5~95% (non-condensing)	5~95% (non-condensing)	5~95% (non-condensing)
	Shock resistance	10 ~ 25HZ (XYZ direction 2G/30 minutes)	10 ~ 25HZ (XYZ direction 2G/30 minutes)	10 ~ 25HZ (XYZ direction 2G/30 minutes)	10 ~ 25HZ (XYZ direction 2G/30 minutes)
	Shell material	engineering plastic ABS+PC	engineering plastic ABS+PC	engineering plastic ABS+PC	engineering plastic ABS+PC
Power supply	Power consumption (W)	7	7	7	7
	Power supply voltage	(DC12~24V)±15%	(DC12~24V)±15%	(DC12~24V)±15%	(DC12~24V)±15%
	Static level	±6kV	±6kV	±6kV	±6kV
Display	Resolution (PX)	1024 × 600	1024 × 600	1024 × 758	1024 × 758
	Contrast	400:1	400:1	450:1	450:1
	Brightness (cd/m <sup>2</sup> )	450	450	300	300
	Touch panel	4-wire high precision touch pane	4-wire high precision touch pane	4-wire high precision touch pane	4-wire high precision touch pane
	Display colors	16.77 million	16.77 million	16.77 million	16.77 million
	Backlight Module	LED	LED	LED	LED
Hardware	Storage	128MB DDR3	128MB DDR3	128MB DDR3	128MB DDR3
	CPU	Cortex A8 600MHZ	Cortex A8 600MHZ	Cortex A8 600MHZ	Cortex A8 600MHZ
	RAM	128MB FLASH	128 MB FLASH	128 MB FLASH	128 MB FLASH
Interface	Network interface	NO	Ethernet	NO	Ethernet
	WIFI	NO	NO	NO	NO
	4G	NO	NO	NO	NO
	USB download port	YES	YES	YES	YES
	U disk port	YES	YES	YES	YES
	Wiring port	COM1 :RS232/422/485 COM2:RS485	COM1 :RS232/422/485 COM2:RS485	COM1 COM2: RS232/422/485	COM1 COM2: RS232/422/485
	Can interface	NO	NO	NO	NO
Other parameters	FCC Compatibility	Complies with FCC, Class A	Complies with FCC, Class A	Complies with FCC, Class A	Complies with FCC, Class A
	Withstand voltage test	1000V AC, 1 minute	1000V AC, 1 minute	1000V AC, 1 minute	1000V AC, 1 minute
	CE certification	Complies with EN55032 and EN55035 standards	Complies with EN55032 and EN55035 standards	Complies with EN55032 and EN55035 standards	Complies with EN55032 and EN55035 standards
	Protection class	IP65(front panel)	IP65(front panel)	IP65(front panel)	IP65(front panel)
	Configuration Software	SKTOOL	SKTOOL	SKTOOL	SKTOOL

Product Size

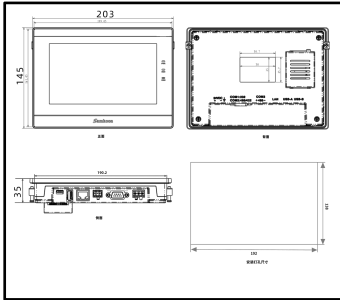

SK-070QE-G/SK-070QT-G/SK-070QS-G

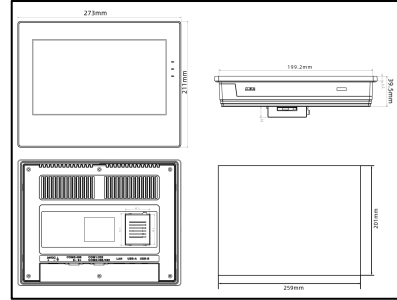

SK-102QT-G/SK-102QS-G

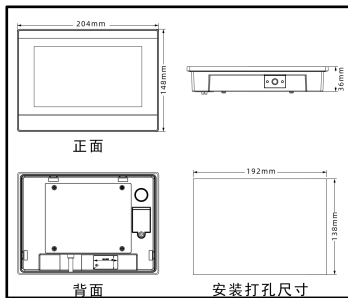

SK-070QF

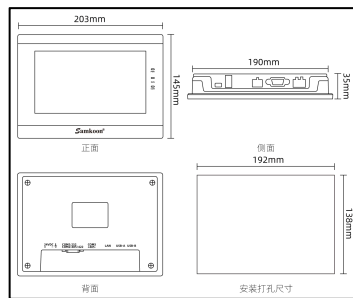

SK-070QH/QS/QE/QT

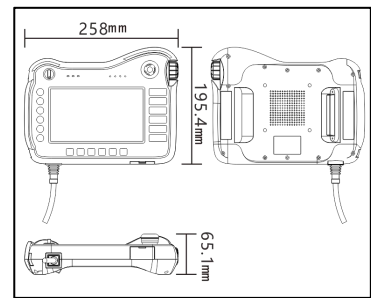

SK-T070XS(hold)

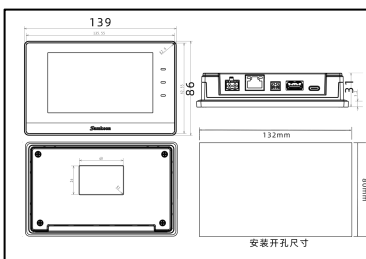

SK-043QS

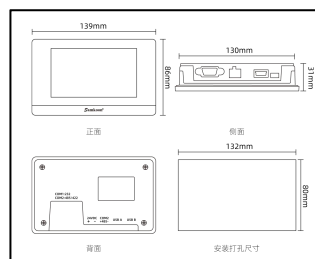

SK-043QE/QT

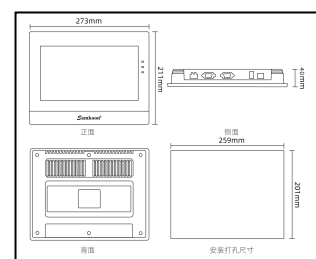

SK-102QS/QT

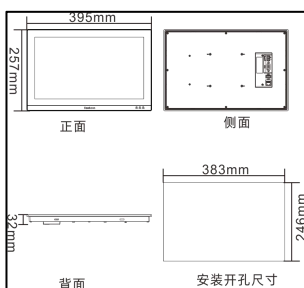

SK-156QS



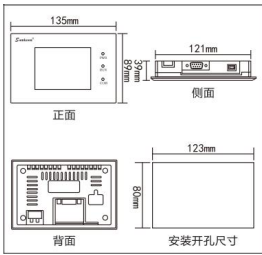

SK-035FE

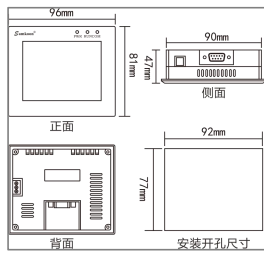

SK-035UE

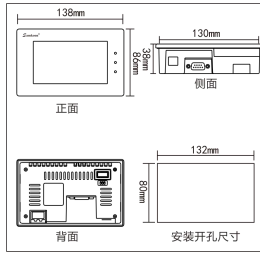

SK-043UE

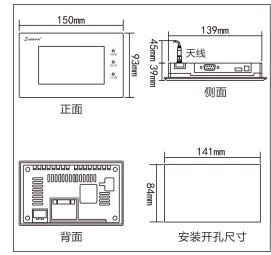

SK-043FE

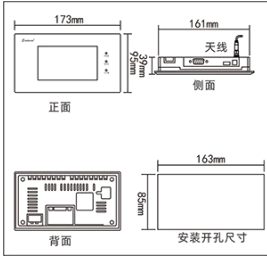

SK-043HE

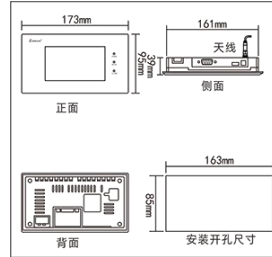

SK-043HS

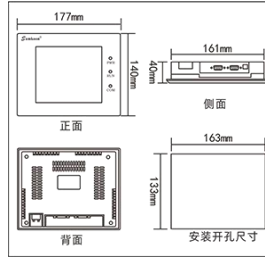

SK-057FE

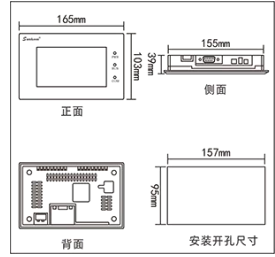

SK-050HE

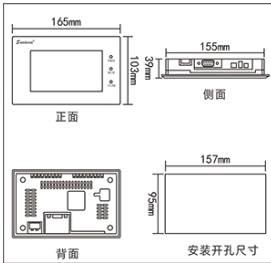

SK-050HS

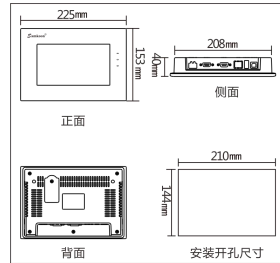

SK-070GE

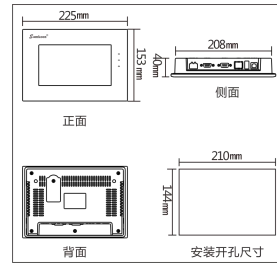

SK-070GS

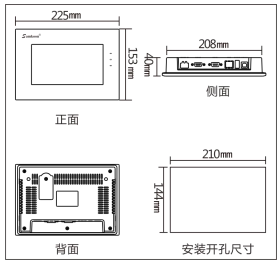

SK-070GG

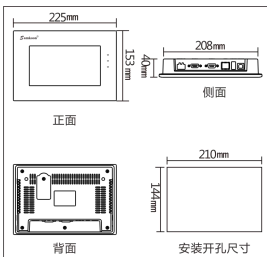

SK-070GW

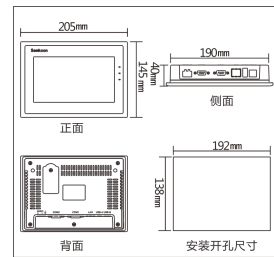

SK-070ME

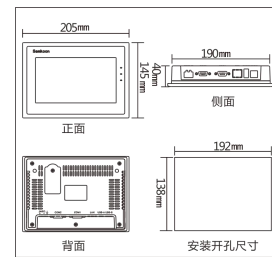

SK-070MS

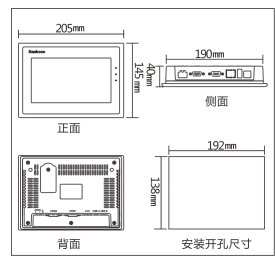

SK-070MG

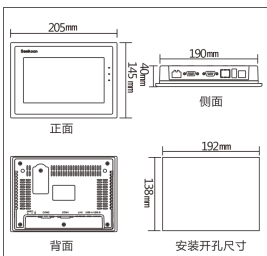

SK-070MW

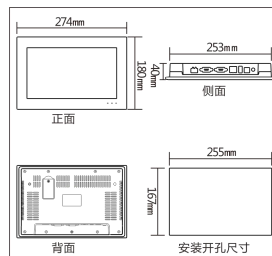

SK-102CE

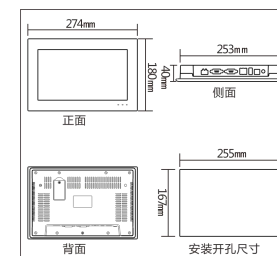

SK-102CS

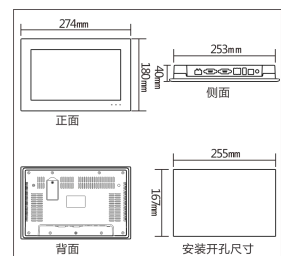

SK-102CG

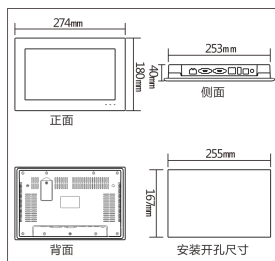

SK-102CW

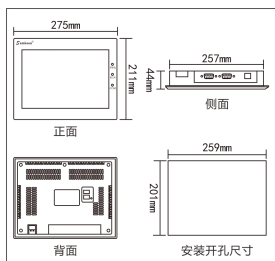

SK-102HE

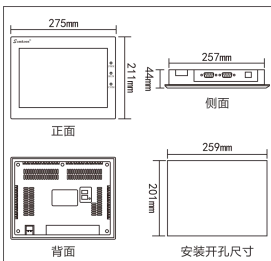

SK-102HS

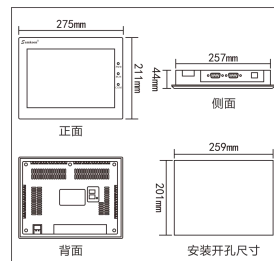

SK-102HG

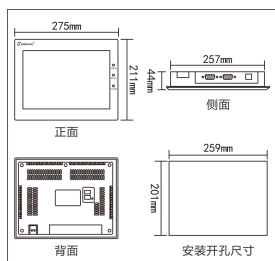

SK-102HW

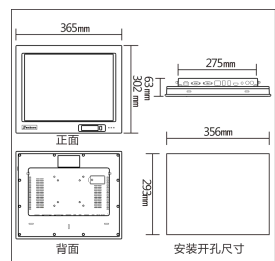

SK-H150AS

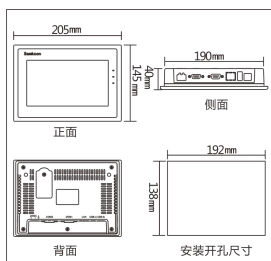

SK-070ME (V3版本)

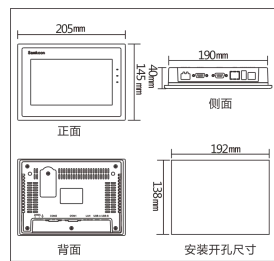

SK-070MS (V3版本)

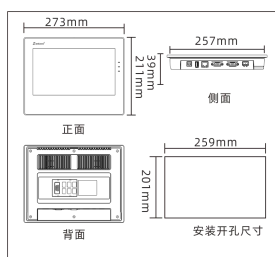

SK-102HE (V3.0)

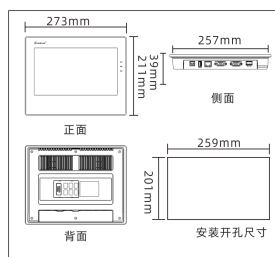

SK-102HS (V3.0)

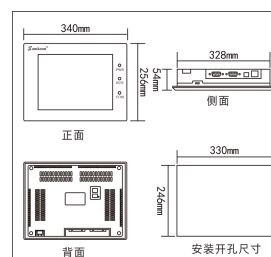

SK-121FE

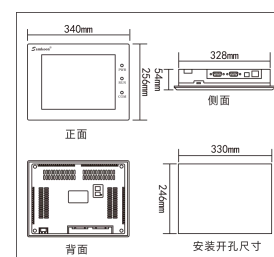

SK-121FS

## EA Series HMI





**Product Features**

**1.High-performance configuration**

- Real-time system, safe, reliable
- High capacity128MB FLASH+64MB DDR3
- Industrial high-performance ARM9 processor, main frequency up to 300MHz

**3.Multiple interface embedding**

- Built-in single COM integrated RS232/422/485 communication mode, support USB download

**5.Abundant choice of color**

- 260,000 true color display

**2.Dversified functional modules**

- Pretty interface, easy to handle, full functions

**4.Brand new crypto system**

- Multiple security system, safe and reliable

**6.High-standard quality control**

- Qualified by FCC, Class A, CE

**Naming Rules**

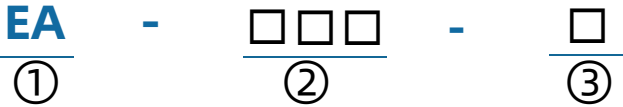

- ① EA: EA Series HMI
- ② 035: display size3.5"  
043: display size4.3"  
070: display size7.0"
- ③ A/B: different hole size

## Product specifications

Model		EA-035A-T	EA-043A	EA-070B
Structure and environment	Size(mm)	86x86x40.5	138x86x38	205x145x40
	Hole size (mm)	69x69	132x80	192x138
	Display size (mm)	3.5"(4:3)	4:3"(16:9)	7"(16:9)
	Weight (g)	140	200	500g
	Working environment temperature	-20°C~55°C (no freezing)	-20°C~55°C (no freezing)	-20°C~55°C (no freezing)
	Working environment humidity	5~95% (non-condensing)	5~95% (non-condensing)	5~95% (non-condensing)
	Shock resistance	10 ~ 25HZ (XYZ direction 2G/30 minutes)	10 ~ 25HZ (XYZ direction 2G/30 minutes)	10 ~ 25HZ (XYZ direction 2G/30 minutes)
	Shell material	engineering plastic ABS+PC	engineering plastic ABS+PC	engineering plastic ABS+PC
Power supply	Power consumption (W)	3	3	4.5
	Power supply voltage	(DC12~24V)±15%	(DC12~24V)±15%	(DC12~24V)±15%
	Static level	± 6kV	± 6kV	± 6kV
Display	Resolution (PX)	320x240	480x272	800x480
	Contrast	400:1	400:1	450:1
	Brightness (cd/m <sup>2</sup> )	350	400	450
	Touch panel	4-wire high precision touch pane	4-wire high precision touch pane	4-wire high precision touch pane
	Display colors	26 million	26 million	26 million
	Backlight Module	LED	LED	LED
Hardware	Storage	64M DDR2	64M DDR2	128MB DDR3
	CPU	ARM9 300MHZ	ARM9 300MHZ	Cortex A7 1GHz. Dual Core
	RAM	128M FALSH	128MB FLASH	128MB FLASH
Interface	Network interface	NO	NO	NO
	USB download port	YES	YES	YES
	U disk port	NO	YES	YES
	Wiring port	COM:RS485	COM:RS232/422/485	COM:RS232/422/485
Other parameters	FCC Compatibility	Complies with FCC, Class A	Complies with FCC, Class A	Complies with FCC, Class A
	Withstand voltage test	1000V AC, 1 minute	1000V AC, 1 minute	1000V AC, 1 minute
	CE certification	Complies with EN55032 and EN55035 standards	Complies with EN55032 and EN55035 standards	Complies with EN55032 and EN55035 standards
	Protection class	IP65(front panel)	IP65(front panel)	IP65(front panel)
	Configuration Software	SATOOL	SATOOL	SATOOL

## Product Size

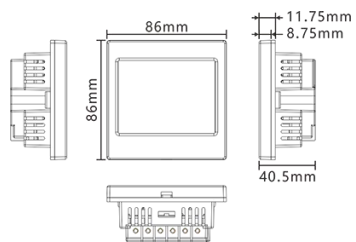

EA-035A-T

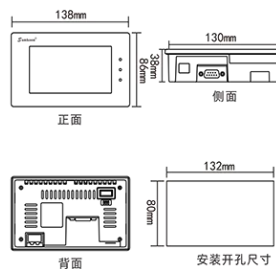

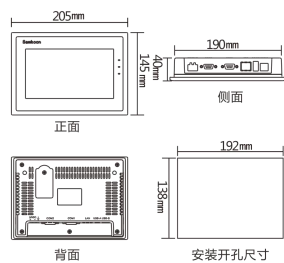

EA-043A



EA-070B

USB download cable

Product Image	Corresponding Product Model
	SK-070QT-G, SK-070QE-G, SK-070QS-G, SK-102QT-G, SK-102QS-G, SK-043QS
	SK-043QE, SK-043QT, SK-070QF, SK-070QE, SK-070QT, SK-070QH, SK-070QS, SK-T070XS, SK-H150AS
	SK-102QS, SK-102QT, SK-035FE, SK-035UE, SK-043FE, SK-043HS, SK-043HE, SK-043UE, SK-043TE, SK-050HS, SK-050HE, SK-057FE, SK-070GE, SK-070GG, SK-070GW, SK-070GS, SK-070MG, SK-070ME, SK-070MW, SK-070MS, SK-070ME/MS (V3.0), SK-102HE/HS (V3.0), SK-102HG, SK-102HS, SK-102HW, SK-102HE, SK-102CG, SK-102CE, SK-102CW, SK-102CS, SK-121FE, SK-121FS, EA-035A-T, EA-043A, EA-070B

Communication Cable

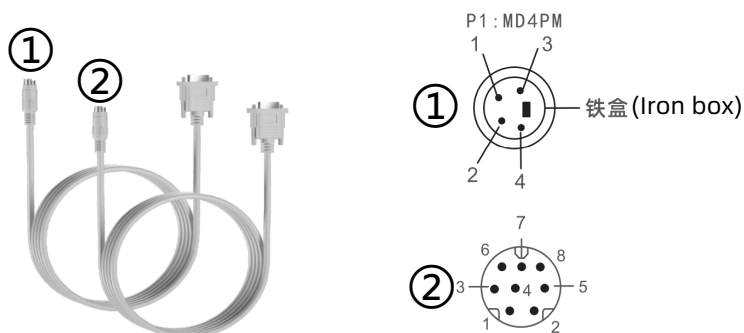

**NOTE:**

①FAs series PLC, FAT series PLC Communication Cable

②FGR serie PLC, FGs serie PLC, FGm series PLC Communication Cable



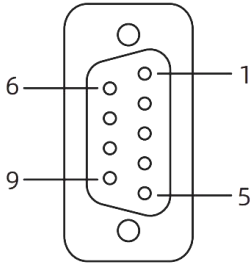

DB9M(Male head)

SK series communication port 9-pin arrangement diagram of male seat

PIN	RS232	RS422	RS485
1			
2	RX		
3	TX		
4			
5	GND		
6		RX-	
7		RX+	
8		TX-	B-
9		TX+	A+

This port is used to connect PLC or other controllers with RS232/RS422/RS485 communication ports

1. The USB communication cable is used for uploading and downloading project files connecting the PC and the man-machine interface;
2. The communication cable connects the PLC and the man-machine interface to realize data communication, and the corresponding cable can be selected according to the PLC model used by the customer;

Note: Before using please read the product manual In detail.

### Install the fixings



## Based in China , Serving the world

Samkoon has been deeply engaged in the field of industrial automation for more than 10 years. Our products are exported to more than 30 countries and regions. Serving domestic and foreign leading enterprises in various industries, providing high-quality products and services for customers of different scales.



### SHENZHEN SAMKOON TECHNOLOGY CO.LTD

R&D center address: 4th Floor, Block 2, Shenzhen software park,  
Middle Zone of High-tech, Nanshan District, Shenzhen, China.

Production base address

Building 7 , Fashion Industry Park, E'BU Town, ShenShan Special  
cooperation zone, ShenZhen City, Guangdong Province, China

Tel: 0755-29419028/38/68

Fax: 0755-29455559

E-mail: samkoon@samkoon.com.cn

Website: www.samkoon.com.cn

The performance and specifications of the products published in this catalog are subject to change without prior notice due to product improvements, etc. Please understand.

National Service Hotline:  
400-606-9669



Website



WeChat official account