

INOVANCE



User Guide

IS620P & ISMH Series

AC Servo Drive and Motor

Pulse & Analog Reference



A03
Data code 19010417

Contents

Safety Information and Precautions	3
Chapter 1 Product Information	5
1.1 Servo Drive.....	5
1.1.1 Designation Rules and Nameplate.....	5
1.1.2 Specifications of Servo Drive	5
1.1.3 Specifications of Regenerative Resistor.....	6
1.2 Servo Motor	7
1.2.1 Designation Rules and Nameplate.....	7
1.2.2 Specifications of Servo Motor	8
1.3 Physical Appearance and Mounting Dimensions of Servo Drive.....	10
1.4 Environment	11
Chapter 2 Wiring	12
2.1 Servo System Wiring	12
2.2 Wiring in Different Modes	14
2.3 Terminals of Servo Drive.....	18
2.3.1 Main Circuit Terminals.....	19
2.3.2 Control Signal Terminal Connector CN1.....	21
2.3.3 Communication Signal Terminal Connectors CN3/CN4.....	23
2.3.4 Analog Monitoring Signal Terminal Connector CN5.....	24
2.4 Cables	24
2.4.1 Cable Model.....	24
2.4.2 Cable Connectors	27
Chapter 3 Operation and Display	33
3.1 Introduction to Keypad.....	33
3.2 Keypad Display.....	33
3.2.1 Display Switchover.....	34
3.3 Parameter Setting.....	34
3.4 User Password	35
Chapter 4 Quick Setup.....	37
Chapter 5 Troubleshooting.....	42
5.1 During Startup	42
5.1.1 Position Control	42
5.1.2 Speed Control.....	44
5.1.3 Torque Control	47
5.2 During Running.....	49
5.2.2 Troubleshooting of Faults.....	49
5.2.3 Troubleshooting of Warnings.....	66

5.2.4 Internal Faults	70
Chapter 6 Parameter Table	71
Group H00: Servo Motor Parameters	71
Group H01: Servo Drive Parameters	72
Group H02: Basic Control Parameters	72
Group H03: Input Terminal Parameters	74
Group H04: Output Terminal Parameters	76
Group H05: Position Control Parameters	77
Group H06: Speed Control Parameters	81
Group H07: Torque Control Parameters	81
Group H08: Gain Parameters	83
Group H09: Automatic Gain Tuning Parameters	84
Group H0A: Fault and Protection Parameters	85
Group H0B: Monitoring Parameters	86
Group H0C: Communication Parameters	88
Group H0D: Auxiliary Function Parameters	89
Group H0F: Fully Closed-Loop Parameters	89
Group H11: Multi-Position Function Parameters	90
Group H12: Multi-Speed Function Parameters	93
Group H17: VDI/VDO Parameters	96
Group H30: Servo Variables Read via Communication	98
Group H31: Servo Variables Set via Communication	98
DI/DO Function Definitions	99

Safety Information and Precautions

This User Guide is packaged together with the IS620P Servo Drive. It contains basic information for quick start of the drive. For safety and more information, please refer to the IS620P Advanced User Guide, which can be downloaded on the website <http://www.inovance.cn>.

■ Electrical Safety

Extreme care must be taken at all times when working with the Servo Drive or within the area of the Servo Drive. The voltages used in the Servo Drive can cause severe electrical shock or burns and is potentially lethal. Only authorized and qualified personnel should be allowed to work on Servo Drives.

■ Machine/System Design and Safety of Personnel

Machine/system design, installation, commissioning startups and maintenance must be carried out by personnel who have the necessary training and experience. They must read this safety information and the contents of this manual. If incorrectly installed, the Servo Drive may present a safety hazard.

The Servo Drive uses high voltages and currents (including DC), carries a high level of stored electrical energy in the DC bus capacitors even after power OFF. These high voltages are potentially lethal.

The Servo Drive is NOT intended to be used for safety related applications/functions. The electronic "STOP & START" control circuits within the Servo Drive must not be relied upon for the safety of personnel. Such control circuits isolates mains power voltages from the output of the Servo Drive. The mains power supply must be disconnected by an electrical safety isolation device before accessing the internal parts of the Servo Drive.

Safety risk assessments of the machine or process system which uses a Servo Drive must be undertaken by the user and or by their systems integrator/designer. In particular the safety assessment/design must take into consideration the consequences of the Servo Drive failing or tripping out during normal operation and whether this leads to a safe stop position without damaging machine, adjacent equipment and machine operators/users. This responsibility lies with the user or their machine/process system integrator.

System integrator/designer must ensure the complete system is safe and designed according to the relevant safety standards. Inovance Technology and Authorized Distributors can provide recommendations related to the Servo Drive to ensure long term safe operation.

The installer of the Servo Drive is responsible for complying with all relevant regulations for wiring, circuit fuse protection, earthing, accident prevention and electromagnetic (EMC regulations). In particular fault discrimination for preventing fire risk and solid earthing practices must be adhered to for electrical safety (also for good EMC practice). Within the European Union, all machinery in which this product is used must comply with required directives.

■ Electrical Installation - Safety

Electrical shock risk is always present within a Servo Drive including the output cable leading to the motor terminals. Where dynamic brake resistors are fitted external to the Servo Drive, care must be taken with regards to live contact with the brake resistors, terminals which are at high DC voltage and potentially lethal. Cables from the Servo Drive to the dynamic brake resistors should be double insulated as DC voltages are typically 600 to 700 VDC.

Mains power supply isolation switch should be fitted to the Servo Drive. The mains power supply must be disconnected via the isolation switch before any cover of the Servo Drive can be removed or before any servicing work is undertaken stored charge in the DC bus capacitors of the PWM inverter is potentially lethal after the AC supply has been disconnected. The AC supply must be isolated at least 10 minutes before any work can be undertaken as the stored charge will have been discharged through the internal bleed resistor fitted across the DC bus capacitors.

Whenever possible, it is good practice to check DC bus voltage with a VDC meter before accessing the inverter bridge. Where the Servo Drive input is connected to the mains supply with a plug and socket, then upon disconnecting the plug and socket, be aware that the plug pins may be exposed and internally connected to DC bus capacitors (via the internal bridge rectifier in reversed bias). Wait 10 minutes to allow stored charge in the DC bus capacitors to be dissipated by the bleed resistors before commencing work on

the Servo Drive.

■ **Electrical Shock Hazard**

Ensure the protective earthing conductor complies with technical standards and local safety regulations. Because the leakage current exceeds 3.5 mA in all models, IEC 61800-5-1 states that either the power supply must be automatically disconnected in case of discontinuity of the protective earthing conductor or a protective earthing conductor with a cross-section of at least 10 mm² (Cu) or 16 mm² (Al) must be used. Failure to comply may result in death or serious injury.



When using an earth leakage circuit breaker, use a residual current operated protective device (RCD) of type B (breaker which can detect both AC and DC). Leakage current can cause unprotected components to operate incorrectly. If this is a problem, lower the carrier frequency, replace the components in question with parts protected against harmonic current, or increase the sensitivity amperage of the leakage breaker to at least 200 mA per drive.

Factors in determining leakage current:

- Size of the Servo Drive
- Servo drive carrier frequency
- Motor cable type and length
- EMI/RFI filter

■ **Approvals**

Certification marks on the product nameplate indicate compliance with the corresponding certificates and standards.

Certification	Mark	Directives		Standard	
CE		EMC directives	2014/30/EU	AC servo drive	EN 61800-3
		LVD directives	2014/35/EU	AC servo motor	EN 60034-1
		RoHS directives	2011/65/EU	AC servo drive	EN 61800-5-1
				AC servo motor	EN 60034-1
				EN 50581	
TUV		-	-	AC servo drive	EN 61800-5-1
				AC servo motor	EN 60034-1
UL		-	-	AC servo drive	UL61800-5-1 C22.2 No.14-13
				AC servo motor	UL1004 C22.2 No.100

Note

- The above EMC directives are complied with only when the EMC electric installation requirements are strictly observed.
- Machines and devices used in combination with this drive must also be CE certified and marked. The integrator who integrates the drive with the CE mark into other devices has the responsibility of ensuring compliance with CE standards and verifying that conditions meet European standards.
- The installer of the drive is responsible for complying with all relevant regulations for wiring, circuit fuse protection, earthing, accident prevention and electromagnetic (EMC regulations). In particular fault discrimination for preventing fire risk and solid earthing practices must be adhered to for electrical safety (also for good EMC practice).
- For more information on certification, consult our distributor or sales representative.

Chapter 1 Product Information

1.1 Servo Drive

1.1.1 Designation Rules and Nameplate

Figure 1-1 Designation rules and nameplate of servo drive

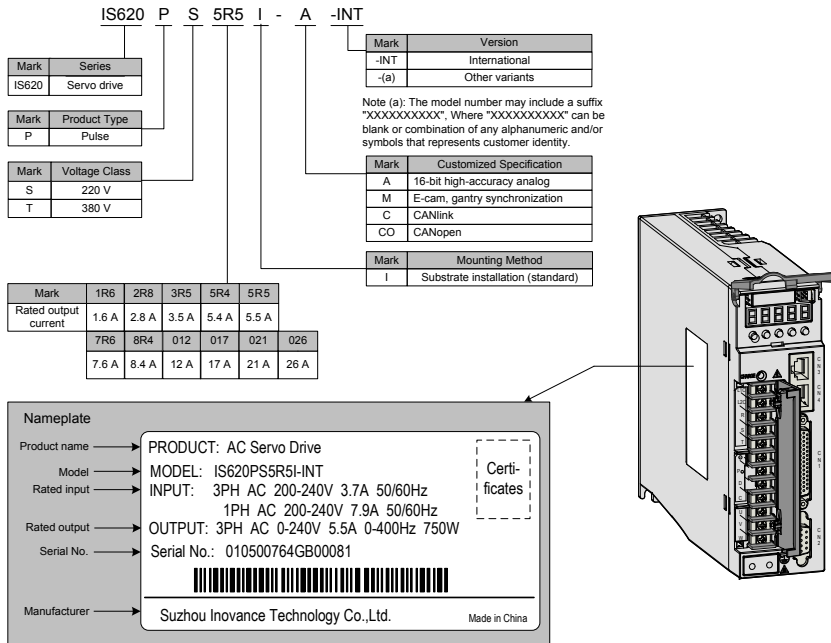

1

1.1.2 Specifications of Servo Drive

Electrical Specifications

■ Single-phase 220 V

Item	SIZE-A		
	S1R6	S2R8	S5R5
Drive model IS620P	S1R6	S2R8	S5R5
Continuous output current Arms	1.6	2.8	5.5
Maximum output current Arms	5.8	10.1	16.9
Main circuit power supply	Single-phase 200 to 240 VAC, +10% to -10%, 50/60 Hz		
Control circuit power supply	Single-phase 200 to 240 VAC, +10% to -10%, 50/60 Hz		
Braking capability	External regenerative resistor	Built-in regenerative resistor	

■ Three-phase 220 V

Item	SIZE-A	SIZE-C	
Drive model IS620P	S5R5	S7R6	S012
Continuous output current Arms	5.5	7.6	11.6
Maximum output current Arms	16.9	17	28
Main circuit power supply	Three-phase 200 to 240 VAC, +10% to -10%, 50/60 Hz		
Control circuit power supply	Single-phase 200 to 240 VAC, +10% to -10%, 50/60 Hz		
Braking capability	Built-in regenerative resistor		

■ Three-phase 380 V

Item	SIZE-C				SIZE-E		
Drive model IS620P	T3R5	T5R4	T8R4	T012	T017	T021	T026
Continuous output current Arms	3.5	5.4	8.4	11.9	16.5	20.8	25.7
Maximum output current Arms	8.5	14	20	24	42	55	65
Main circuit power supply	Three-phase 380 to 480 VAC, +10% to -10%, 50/60 Hz						
Control circuit power supply	Single-phase 380 to 480 VAC, +10% to -10%, 50/60 Hz						
Braking capability	Built-in regenerative resistor						

1.1.3 Specifications of Regenerative Resistor

Drive Model		Built-in Regenerative Resistor Specs		Min. Allowed Resistance (Ω)	Max. Braking Energy Absorbed by Capacitor (J)
		Resistance (Ω)	Power (W)		
Single-phase 220 V	IS620PS1R6I	-	-	50	9
	IS620PS2R8I	-	-	45	18
Single/Three-phase 220 V	IS620PS5R5I	50	50	40	26
Three-phase 220 V	IS620PS7R6I	25	80	20	26
	IS620PS012I			15	47
Three-phase 380 V	IS620PT3R5I	100	80	80	28
	IS620PT5R4I	100	80	60	34
	IS620PT8R4I	50	80	45	50
	IS620PT012I				50
	IS620PT017I	40	100	35	81
	IS620PT021I			25	122
	IS620PT026I				122

Note

Models S1R6 and S2R8 are not configured with a built-in regenerative resistor. Use an external regenerative resistor if necessary.

For use for the external regenerative resistor, refer to the IS620P User Manual.

1.2 Servo Motor

1.2.1 Designation Rules and Nameplate

Figure 1-2 Designation rules and nameplate of servo motor

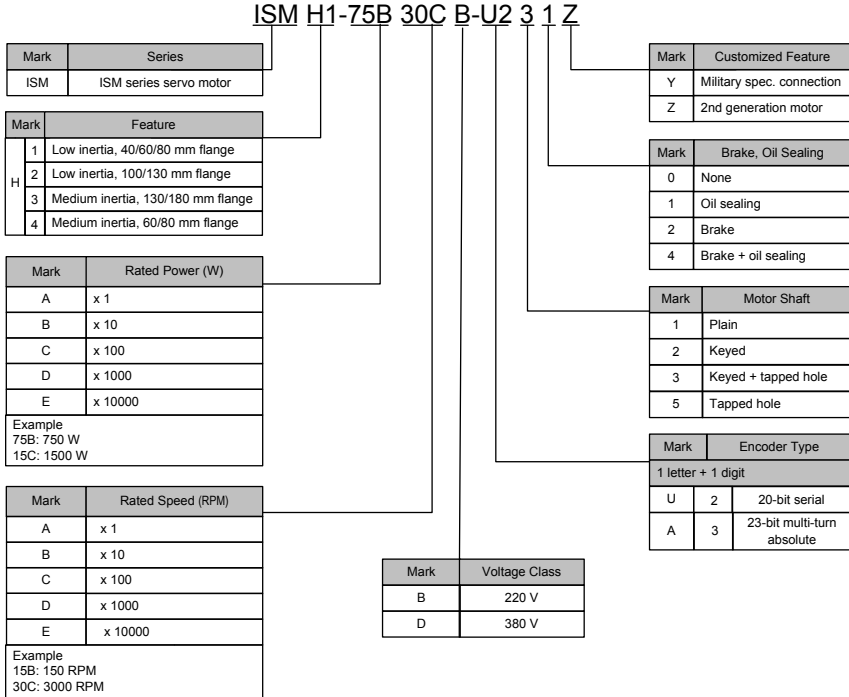

1

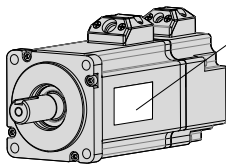

Nameplate	
Product name	→ INOVANCE AC Servo Motor
Model	→ Model: ISMH1-75B30CB-U231Z
Parameters	→ 0.75 kW 220 V 3000 r/min 2.39 N·m 250 Hz 4.8 A Duty S1 Ins. F 3PHAC IP65
Motor code	→ Motor Code: 14000 Weight: 2.7 kg
Manufacturer	→ Suzhou Inovance Technology Co., Ltd.
Serial No.	→ Made in China SN:01110462*****

IEC60034

1.2.2 Specifications of Servo Motor

Motor Mechanical Characteristics

Item	Description
Rated time	Continuous
Vibration level	V15
Insulation resistance	500 VDC, above 10 MΩ
Use ambient temperature	0–40°C
Excitation mode	Permanent magnetic
Installation method	Flange
Heat-resistance level	H1, H4: B; Other: F
Insulation voltage	1500 VAC, 1 minute (200 V) 1800 VAC, 1 minute (400 V)
Housing protection mode	H1, H4: IP65 (except the through-shaft section) Other: IP67
Use environment humidity	20%–80% (no condensation)
Connection mode	Direct connection
Rotating direction	The motor rotates counterclockwise viewed from the load side (CCW) at the forwarding rotation command.

Motor Ratings

Servo Motor Model	Rated Output (kW) (Note 1)	Rated Torque (N·m)	Max. Torque (N·m)	Rated Curr. (A)	Max. Curr. (A)	Rated Speed (RPM)	Max. Speed (RPM)	Torque Para. (N·m/A)	Rotor Inertia (10 ⁻⁴ kg·m ²)	Voltage (V)
ISMH1 (V _n = 3000 RPM, V _{max} = 6000 RPM)										
ISMH1-10B30CB-U***Z	0.1	0.32	0.96	1.1	3.3	3000	6000	0.298	0.046 (0.048) (Note 2)	220
ISMH1-20B30CB-U***Z	0.2	0.63	1.91	1.6	5.12			0.50	0.149 (0.163)	
ISMH1-40B30CB-U***Z	0.4	1.27	3.82	2.8	8.96			0.50	0.25	
ISMH1-55B30CB-U***Z	0.55	1.75	5.25	3.8	12.2			0.496	1.04	
ISMH1-75B30CB-U***Z	0.75	2.39	7.16	4.80	15.10			0.57	1.3	
ISMH1-10C30CB-U***Z	0.75	3.18	9.55	7.6	24.5			0.485	1.7	

Servo Motor Model	Rated Output (kW) (Note 1)	Rated Torque (N·m)	Max. Torque (N·m)	Rated Curr. (A)	Max. Curr. (A)	Rated Speed (RPM)	Max. Speed (RPM)	Torque Para. (N·m/A)	Rotor Inertia (10 ⁻⁴ kg·m ²)	Voltage (V)
ISMH2 (V _n = 3000 RPM, V _{max} = 6000/5000 RPM)										
ISMH2-10C30CB-U***Y	1.0	3.18	9.54	7.5	23.00	3000	6000	0.43	1.87 (3.12)	220
ISMH2-15C30CB-U***Y	1.5	4.90	14.7	10.8	32.00		5000	0.45	2.46 (3.71)	
ISMH2-10C30CD-U***Y	1.0	3.18	9.54	3.65	11.00		6000	0.87	1.87 (3.12)	380
ISMH2-15C30CD-U***Y	1.5	4.90	14.7	4.50	14.00		5000	1.09	2.46 (3.71)	
ISMH2-20C30CD-U***Y	2.0	6.36	19.1	5.89	20.00	3000	5000	1.08	3.06	380
ISMH2-25C30CD-U***Y	2.5	7.96	23.9	7.56	25.00			1.05	3.65	
ISMH2-30C30CD-U***Y	3.0	9.8	29.4	10.00	30.00			0.98	7.72	
ISMH2-40C30CD-U***Y	4.0	12.6	37.8	13.60	40.80			0.93	12.1	
ISMH2-50C30CD-U***Y	5.0	15.8	47.6	16.00	48.00			1.07	15.4	
ISMH3 (V _n = 1500 RPM, V _{max} = 3000 RPM)										
ISMH3-85B15CB-U***Y	0.85	5.39	13.5	6.60	16.50	1500	3000	0.9	13 (15.5)	220
ISMH3-13C15CB-U***Y	1.3	8.34	20.85	10.00	25.00			0.9	19.3 (21.8)	
ISMH3-85B15CD-U***Y	0.85	5.39	13.5	3.30	8.25			1.75	13 (15.5)	380
ISMH3-13C15CD-U***Y	1.3	8.34	20.85	5.00	12.50			1.78	19.3 (21.8)	
ISMH3-18C15CD-U***Y	1.8	11.5	28.75	6.60	16.50			1.8	25.5 (28)	
ISMH3-29C15CD-U***Z	2.9	18.6	37.2	11.90	28.00			1.7	55 (57.2)	
ISMH3-44C15CD-U***Z	4.4	28.4	71.1	16.50	40.50			1.93	88.9 (90.8)	
ISMH3-55C15CD-U***Z	5.5	35.0	87.6	20.85	52.00			1.80	107 (109.5)	
ISMH3-75C15CD-U***Z	7.5	48.0	119	25.70	65.00			1.92	141 (143.1)	
ISMH4 (V _n = 3000 Rpm, V _{max} = 6000 RPM)										
ISMH4-40B30CB-U***Z	0.4	1.27	3.82	2.80	8.96	3000	6000	0.50	(0.667)	220
ISMH4-75B30CB-U***Z	0.75	2.39	7.16	4.80	15.10			0.57	(2.033)	

Note

Note 1: The motor with oil sealing must be derated by 10% during use.
 Note 2: Parameters in () are for the motor with brake.
 The parameters in the preceding table are the values when the motor works together with Inovance servo drive and the armature coil temperature is 20°C.
 The preceding features are based on the cooling conditions when the following heatsinks are installed.
 ISMH1/ISMH4: 250 x 250 x 6 mm (aluminum)
 ISMH2-10C to 25C: 300 x 300 x 12 mm (aluminum)
 ISMH2-30C to 50C: 400 x 400 x 20 mm (aluminum)
 ISMH3-85B to 18C: 400 x 400 x 20 mm (iron)
 ISMH3-29C to 75C: 360 x 360 x 5 mm (double aluminum plate)

1.3 Physical Appearance and Mounting Dimensions of Servo Drive

SIZE A: IS620PS1R6I, IS620PS2R8I, IS620PS5R5I

SIZE C: IS620PS7R6I, IS620PS012I, IS620PT3R5I, IS620PT5R4I, IS620PT8R4I, IS620PT012I

SIZE E: IS620PT017I, IS620PT021I, IS620PT026I

Figure 1-3 Physical appearance and mounting dimensions of servo drive

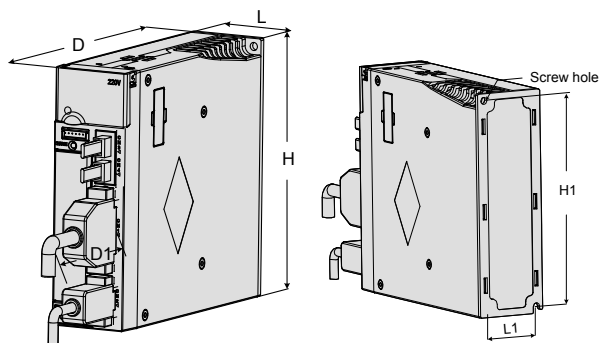

Size	L (mm)	H (mm)	D (mm)	L1 (mm)	H1 (mm)	D1 (mm)	Screw Hole	Tightening Torque (Nm)
SIZE A	50	160	173	40	150	75	2-M4	0.6 to 1.2
SIZE C	90	160	183	80	150	75	4-M4	0.6 to 1.2
SIZE E	100	250	230	90	240	75	4-M4	0.6 to 1.2

1.4 Environment

Item	Servo Drive	Servo Motor
Use ambient temperature	0–55°C (average load ratio not exceeding 80% when ambient temperature is within 40–55°C) (non-freezing)	0 to 40°C (non-freezing)
Use environment humidity	Below 90% RH (no condensation)	20%–90% RH (no condensation)
Storage temperature	-20 to 85°C (non-freezing)	-20 to 60°C (Peak temperature ensurance: 80°C for 72 hours)
Storage humidity	Below 90% RH (no condensation)	20%–90% RH (no condensation)
Vibration	Below 4.9 m/s ²	Below 49 m/s ²
Impact	Below 19.6 m/s ²	Below 490 m/s ²
Ingress protection	IP10	H1/H4: IP65 (except for the through-shaft section and motor connectors) Other: IP67 (except for the through-shaft section and motor connectors)
Pollution degree	PD2	PD2
Overvoltage category	OVCIII	-
Altitude	< 1000 m	< 1000 m (de-rated if the altitude is above 1000 m)

Chapter 2 Wiring

2.1 Servo System Wiring

Figure 2-1 Wiring example of single-phase 220 V system

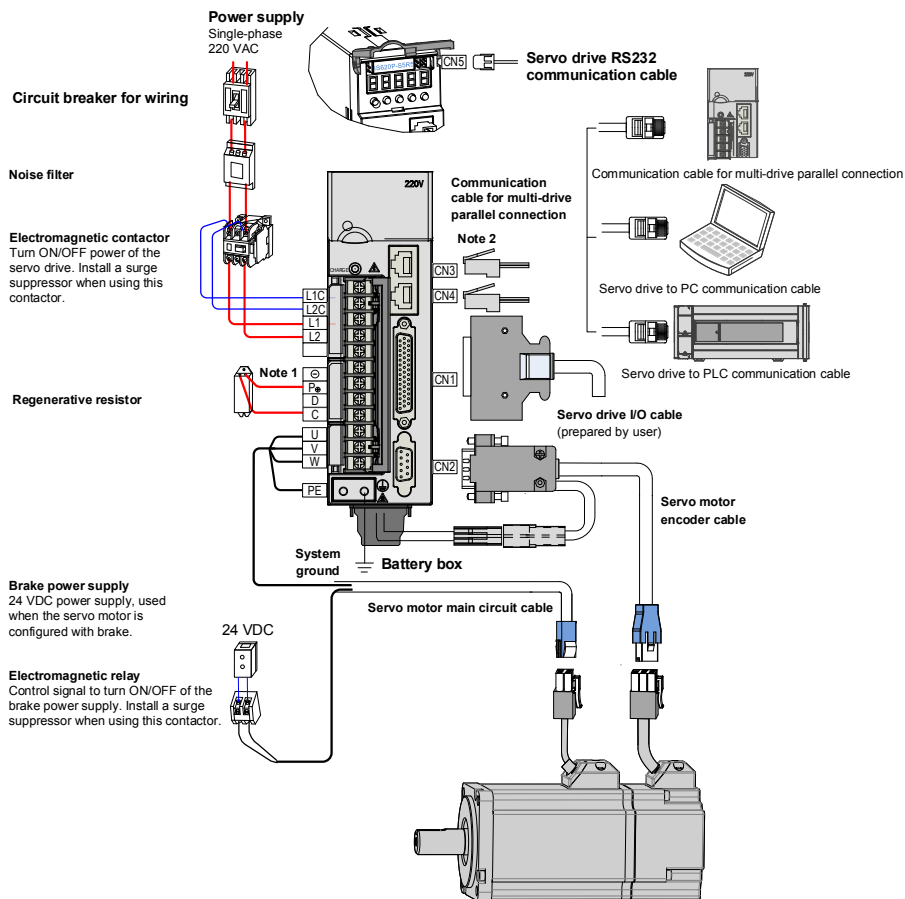

The servo drive is directly connected to an industrial power supply, with no isolation such as transformer. In this case, a fuse or circuit breaker must be connected on the input power supply to prevent cross electric accidents in the servo system. The servo drive is not configured with the built-in protective grounding circuit. Thus, connect a residual current device (RCD) against both overload and short-circuit or a specialized RCCB combined with protective grounding.

It is forbidden to run or stop the motor by using the electromagnetic contactor. As a high-inductance device, the motor generates instantaneous high voltage, which may damage the contactor.

Pay attention to the power capacity when connecting an external control power supply or 24 VDC,

especially when the power supply is for powering up multiple drives or brakes. Insufficient power supply will lead to lack of supply current, thus causing failure of the drives or brakes. The brake shall be powered up by a 24 VDC power supply. The power must match the motor model and meets the brake requirements.

Note

1. Remove the jumper between terminals P_{\oplus} and D of the servo drive when connecting a regenerative resistor.
2. CN3 and CN4 are identical communication ports with the same pin definition, and either can be used.

Figure 2-2 Wiring example of three-phase 220 V/380 V system

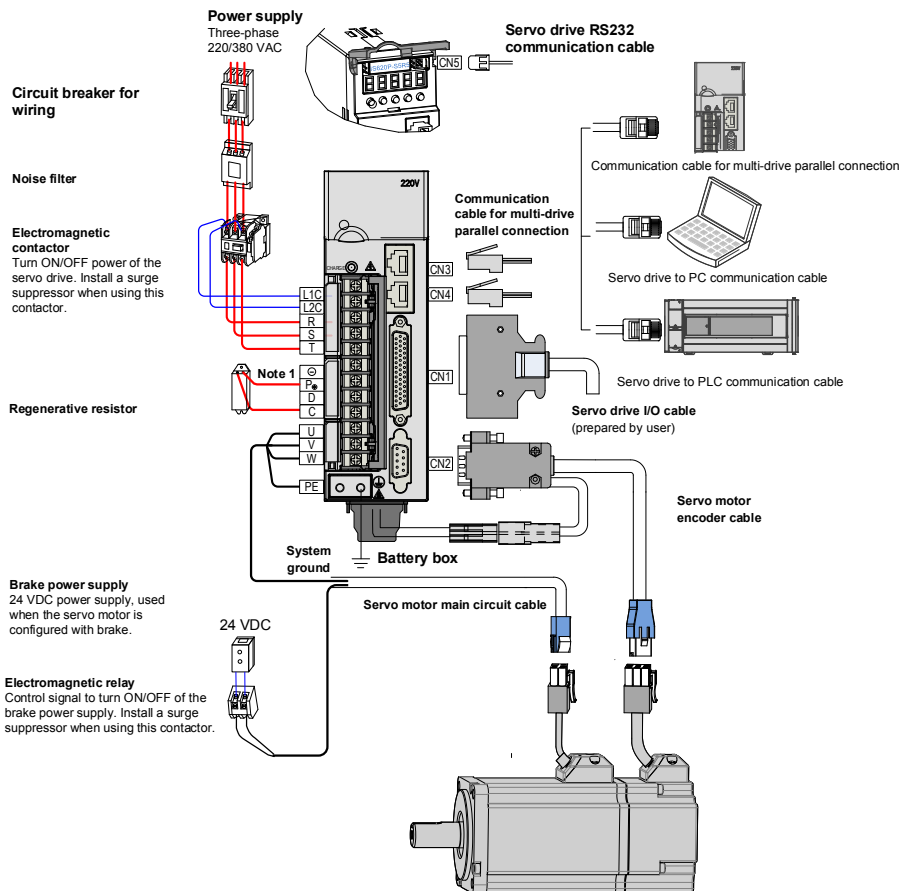

The servo drive is directly connected to an industrial power supply, with no isolation such as transformer. In this case, a fuse or circuit breaker must be connected on the input power supply to prevent cross electric accidents in the servo system. The servo drive is not configured with the built-in protective grounding circuit. Thus, connect a RCD against both overload and short-circuit or a specialized RCD combined with protective grounding.

It is forbidden to run or stop the motor by using the electromagnetic contactor. As a high-inductance device,

the motor generates instantaneous high voltage, which may damage the contactor.

Pay attention to the power capacity when connecting an external control power supply or 24 VDC, especially when the power supply is for powering up multiple drives or brakes. Insufficient power supply will lead to lack of supply current, thus causing failure of the drives or brakes. The brake shall be powered up by a 24 VDC power supply. The power must match the motor model and meets the brake requirements.

Note

1. Remove the jumper between terminals P_b and D of the servo drive when connecting a regenerative resistor.
2. CN3 and CN4 are identical communication ports with the same pin definition, and either can be used.

2.2 Wiring in Different Modes

The following are the notices for the wiring diagrams in three different modes:

- Use the shielded twisted-pair as the AI/AO circuit cables, with both ends of the shield tied to PE.
- Internal +24V power supply, voltage range: 20–28 V, maximum output current: 200 mA
- DI8 and DI9 are high-speed DIs. Use them according to their functions allocated.
- Use the shielded twisted-pair as the cables of the high-speed/low-speed pulse terminals, with both ends of the shield tied to PE. Connect GND and signal ground of the host controller reliably.
- Use the shielded twisted-pair as the encoder frequency-division cables, with both ends of the shield tied to PE. Connect GND and signal ground of the host controller reliably.
- Customers need to prepare the power supply for DOs, with voltage range 5–24 V. The DO terminals support 30 VDC voltage and 50 mA current to the maximum.
- The internal +5 V power supply supports a maximum of 200 mA current.

Figure 2-3 Wiring of the position control mode

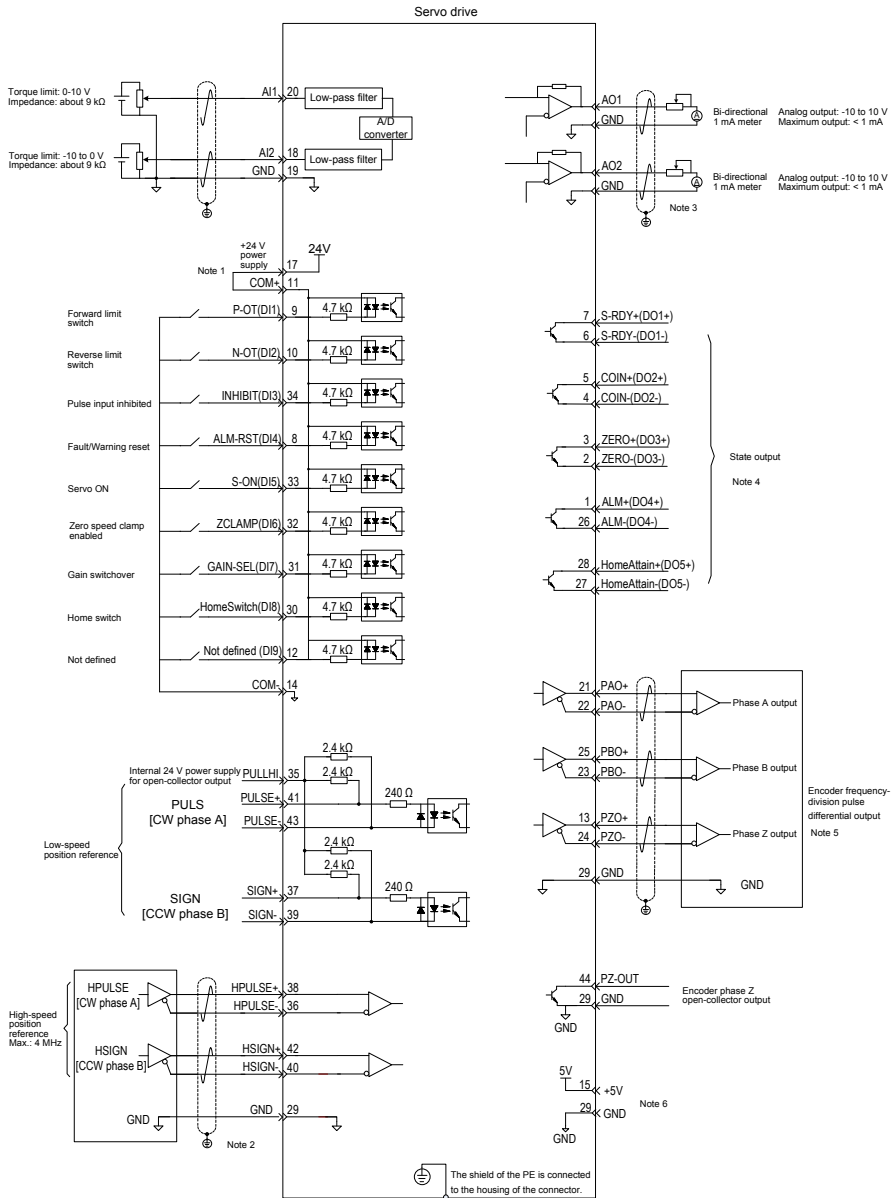

Figure 2-4 Wiring of the speed control mode

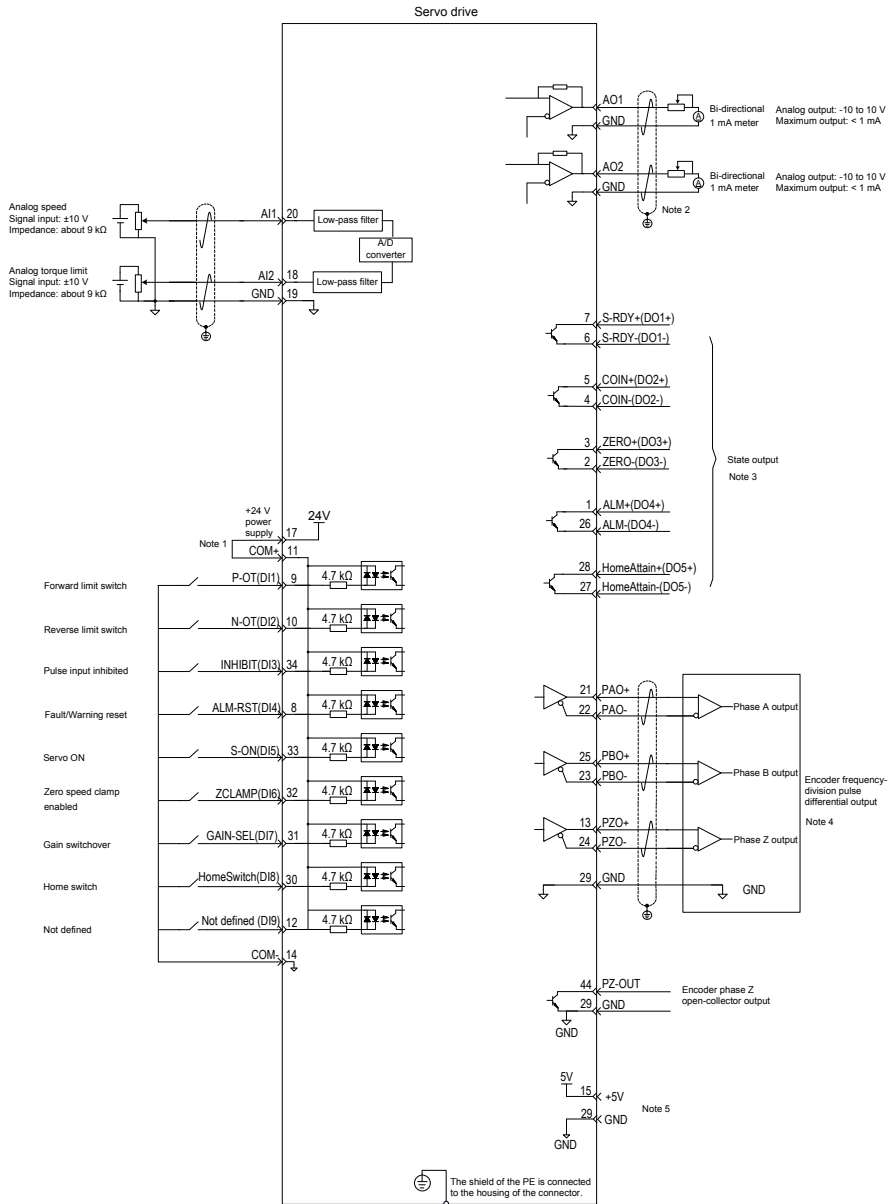
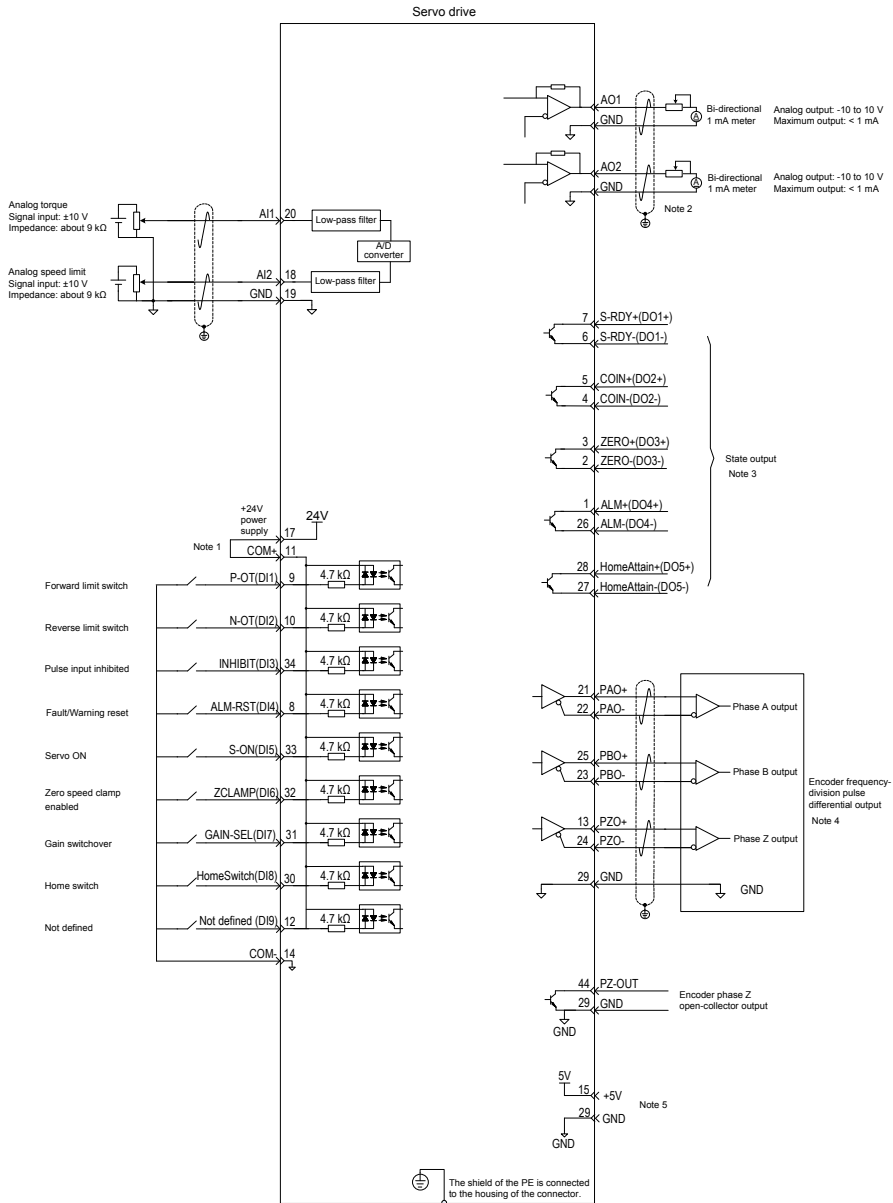
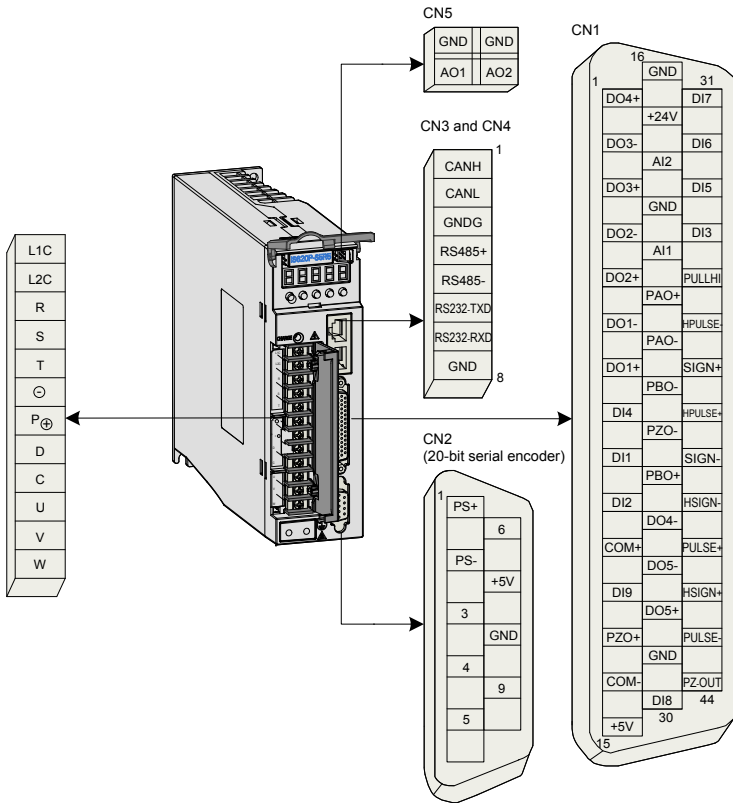

Figure 2-5 Wiring of the torque control mode



2.3 Terminals of Servo Drive

Figure 2-6 Terminal arrangement of IS620P



The preceding figure shows arrangement of the terminals in the servo drive.

2.3.1 Main Circuit Terminals

Figure 2-7 Terminal block arrangement of SIZE A (SIZE C)

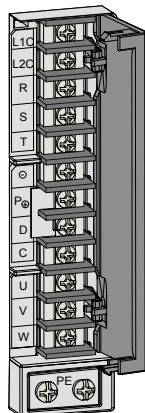

Table 2-1 Names and functions of main circuit terminals of SIZE A (SIZE C)

Terminal Symbol	Terminal Name	Terminal Function
L1, L2	Power input terminals	Single-phase power input. Connect 220 VAC power supply between L1 and L2 terminals.
R, S, T		Three-phase 220 V/380 V power input according to the nameplate.
L1C, L2C	Control power input terminals	Connect to control power input. For specific value, refer to the rated voltage on the nameplate.
PⓄ, D, C	Terminals for connecting external regenerative resistor	Connect an external regenerative resistor between PⓄ and C if the braking capacity is insufficient. The external regenerative resistor needs to be purchased additionally.
		Terminals PⓄ and D are shorted by default. Remove the jumper between PⓄ and D, and connect an external regenerative resistor between PⓄ and C if the braking capacity is insufficient. The external regenerative resistor needs to be purchased additionally.
PⓄ, Ⓞ	Common DC bus terminal	They are used for common DC bus connection when multiple servo drives are used in parallel.
U, V, W	Servo motor connection terminals	Connect to U, V and W phases of the servo motor.
PE	Ground	Two grounding terminals of the servo drive are respectively connected to those of the power supply and the servo motor. The entire system must be grounded.

Figure 2-8 Terminal block arrangement of SIZE E

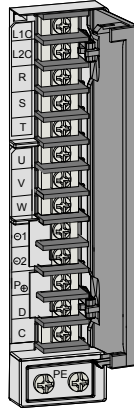
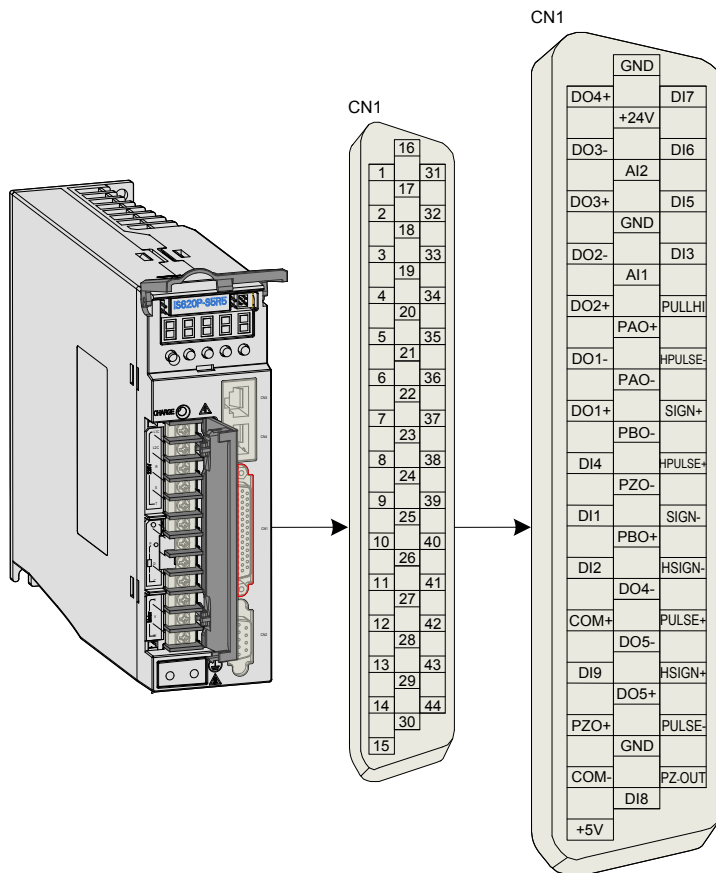

Table 2-2 Names and functions of main circuit terminals of SIZE E

Terminal Symbol	Terminal Name	Terminal Function
R, S, T	Main circuit power input terminals	Main circuit three-phase 380 V power input.
L1C, L2C	Control power input terminals	Connect to control power input. For specific value, refer to the rated voltage on the nameplate.
P⓪, D, C	Terminals for connecting external regenerative resistor	Terminals P⓪ and D are shorted by default. Remove the jumper between P⓪ and D, and connect an external regenerative resistor between P⓪ and C if the braking capacity is insufficient. The external regenerative resistor needs to be purchased additionally.
P⓪, ⓪1 / ⓪2	Common DC bus terminal	They are used for common DC bus connection when multiple servo drives are used in parallel.
⓪1, ⓪2	Terminals for connecting external reactor	Terminals ⓪1 and ⓪2 are shorted by default. When the power harmonic current need to be restricted, remove the jumper and connect a reactor between ⓪1 and ⓪2.
U, V, W	Servo motor connection terminals	Connect to U, V and W phases of the servo motor.
PE	Ground	Two grounding terminals of the servo drive are respectively connected to those of the power supply and the servo motor. The entire system must be grounded.

2.3.2 Control Signal Terminal Connector CN1

Figure 2-9 Pin layout of control circuit terminal connector of servo drive



2

Position Reference Signal

Table 2-3 Position reference signal description

Signal	Pin No.	Function Description	
Position reference	PULSE+	41	Low-speed pulse input mode Differential drive mode OC mode
	PULSE-	43	
	SIGN+	37	
	SIGN-	39	
	HPULSE+	38	High-speed reference pulse input
	HPULSE-	36	

Signal		Pin No.	Function Description
Position reference	HSIGN+	42	High-speed position reference symbols
	HSIGN-	40	
	PULLHI	35	External power input terminal of reference pulse
	GND	29	Signal ground

AI Signals

Table 2-4 AI signal description

Signal	Default Function	Pin No.	Function Description
Analog	AI2	18	Ordinary analog input signals Resolution: 12 bit; Input voltage: maximum $\pm 12V$
	AI1	20	
	GND	19	Analog input signal ground

Speed and torque analog signal input terminals are AI1 and AI2, resolution of which is 12-bit. Corresponding voltage values are set via group H03 parameters.

Input voltage range: -10 to +10 V; resolution: 12 bit;

Maximum permissible voltage: $\pm 12 V$;

Input impedance: $\approx 9 k\Omega$

DI/DO Signals

Table 2-5 DI/DO signal description

Signal	Default Function	Pin No.	Function Description	
General	DI1	P-OT	9	Positive limit switch
	DI2	N-OT	10	Negative limit switch
	DI3	INHIBIT	34	Pulse input inhibited
	DI4	ALM-RST	8	Alarm reset (edge valid)
	DI5	S-ON	33	Servo ON
	DI6	ZCLAMP	32	Zero speed clamp
	DI7	GAIN-SEL	31	Gain switchover
	DI8	HomeSwitch	30	Home switch
	DI9	Reserved	12	-
	+24V		17	Internal 24 V power supply, voltage range: 20 to 28 V, maximum output current: 200 mA
	COM-		14	
	COM+		11	
	DO1+	S-RDY+	7	Servo ready
	DO1-	S-RDY-	6	
	DO2+	COIN+	5	Position reached
	DO2-	COIN-	4	
	DO3+	ZERO+	3	Zero speed
	DO3-	ZERO-	2	

Signal		Default Function	Pin No.	Function Description
General	DO4+	ALM+	1	Fault output
	DO4-	ALM-	26	
	DO5+	HomeAttain+	28	Homing completed
	DO5-	HomeAttain-	27	

Encoder Frequency-Division Output Signal

Table 2-6 Encoder frequency-division output signal specifications

Signal	Default Function	Pin No.	Function Description	
General	PAO+	21	Phase A output signal	Phases A+B quadrature pulse output signal
	PAO-	22		
	PBO+	25	Phase B output signal	
	PBO-	23		
	PZO+	13	Phase Z output signal	Home pulse output signal
	PZO-	24		Home pulse OC output signal
	PZ-OUT	44	Phase Z output signal	Home pulse OC output signal
	GND	29	Home pulse OC output signal ground	
+5V	15	5 V internal power supply Maximum output current: 200 mA		
GND	16			
PE	Housing			

The encoder frequency-division output circuit outputs OC signals via the differential drive. Generally, it provides feedback signals to the host controller in the closed-loop position control system. A differential or optocoupler circuit shall be used in the host controller to receive feedback signals. The maximum output current is 20 mA.

2.3.3 Communication Signal Terminal Connectors CN3/CN4

The CN3/CN4 terminals of the servo drive are used for communication connection between the servo drive and the PC, PLC, and other servo drives. The following table describes the pin definitions of the CN3/CN4 terminals.

Table 2-7 Pin definition of communication signal terminal connectors

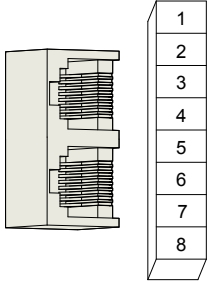
Pin No.	Pin	Description	Pin Layout
1	CANH	CAN communication port	
2	CANL		
3	CGND	CAN communication ground	
4	RS485+	RS485 communication port	
5	RS485-		
6	RS232-TXD	RS232 transmitting end, connected to the receiving end of the host controller	
7	RS232-RXD	RS232 transmitting end, connected to the sending end of the host controller	
8	GND	Ground	
Housing	PE	Shield	

2.3.4 Analog Monitoring Signal Terminal Connector CN5

The following figure shows pin layout of the analog monitoring signal terminal connector CN5.

Figure 2-10 Analog monitoring signal terminal connector

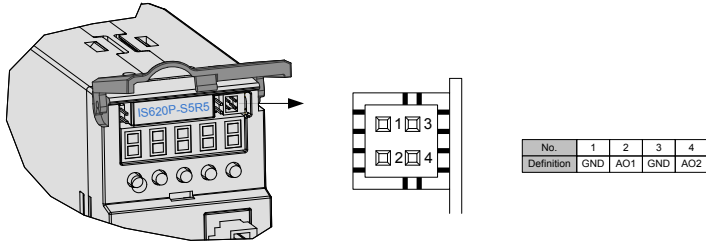

Corresponding interface circuit:

Analog output: -10 to +10 V

Maximum output current: 1 mA

2.4 Cables

2.4.1 Cable Model

Servo Motor Power Cable and Encoder Cable

2

■ **Models Without Brake**

Motor Model	Cable Type	Cable Length		
		L = 3.0 m	L = 5.0 m	L = 10.0 m
ISMH1-*****-U1*** ISMH1-*****-U2*** ISMH4-*****-U1*** ISMH4-*****-U2***	Power cable	S6-L-M00-3.0	S6-L-M00-5.0	S6-L-M00-10.0
	Incremental encoder cable	S6-L-P00-3.0	S6-L-P00-5.0	S6-L-P00-10.0
ISMH1-*****-A3*** ISMH4-*****-A3***	Power cable	S6-L-M00-3.0	S6-L-M00-5.0	S6-L-M00-10.0
	Absolute encoder cable	S6-L-P20-3.0	S6-L-P20-5.0	S6-L-P20-10.0
ISMH2-*****-U1*** ISMH2-*****-U2***	Power cable	S6-L-M11-3.0	S6-L-M11-5.0	S6-L-M11-10.0
	Incremental encoder cable	S6-L-P01-3.0	S6-L-P01-5.0	S6-L-P01-10.0
ISMH2-*****-A3***	Power cable	S6-L-M11-3.0	S6-L-M11-5.0	S6-L-M11-10.0
	Absolute encoder cable	S6-L-P21-3.0	S6-L-P21-5.0	S6-L-P21-10.0
ISMH3-*****-U1*** ISMH3-*****-U2*** (1.8 kW and below)	Power cable	S6-L-M11-3.0	S6-L-M11-5.0	S6-L-M11-10.0
	Incremental encoder cable	S6-L-P01-3.0	S6-L-P01-5.0	S6-L-P01-10.0
ISMH3-*****-A3*** (1.8 kW and above)	Power cable	S6-L-M11-3.0	S6-L-M11-5.0	S6-L-M11-10.0
	Absolute encoder cable	S6-L-P21-3.0	S6-L-P21-5.0	S6-L-P21-10.0
ISMH3-*****-U1*** ISMH3-*****-U2*** (2.9 kW)	Power cable	S6-L-M12-3.0	S6-L-M12-5.0	S6-L-M12-10.0
	Incremental encoder cable	S6-L-P01-3.0	S6-L-P01-5.0	S6-L-P01-10.0
ISMH3-*****-A3*** (2.9 kW)	Power cable	S6-L-M12-3.0	S6-L-M12-5.0	S6-L-M12-10.0
	Absolute encoder cable	S6-L-P21-3.0	S6-L-P21-5.0	S6-L-P21-10.0

Motor Model	Cable Type	Cable Length		
		L = 3.0 m	L = 5.0 m	L = 10.0 m
ISMH3-*****-U1*** ISMH3-*****-U2*** (above 2.9 kW)	Power cable	S6-L-M22-3.0	S6-L-M22-5.0	S6-L-M22-10.0
	Incremental encoder cable	S6-L-P01-3.0	S6-L-P01-5.0	S6-L-P01-10.0
ISMH3-*****-A3*** (above 2.9kW)	Power cable	S6-L-M22-3.0	S6-L-M22-5.0	S6-L-M22-10.0
	Absolute encoder cable	S6-L-P21-3.0	S6-L-P21-5.0	S6-L-P21-10.0

■ **Models with Brake**

Motor Model	Cable Type	Cable Length		
		L = 3.0 m	L = 5.0 m	L = 10.0 m
ISMH1-*****-U1*** ISMH1-*****-U2*** ISMH4-*****-U1*** ISMH4-*****-U2***	Power cable	S6-L-B00-3.0	S6-L-B00-5.0	S6-L-B00-10.0
	Incremental encoder cable	S6-L-P00-3.0	S6-L-P00-5.0	S6-L-P00-10.0
ISMH1-*****-A3*** ISMH4-*****-A3***	Power cable	S6-L-B00-3.0	S6-L-B00-5.0	S6-L-B00-10.0
	Absolute encoder cable	S6-L-P20-3.0	S6-L-P20-5.0	S6-L-P20-10.0
ISMH2-*****-U1*** ISMH2-*****-U2***	Power cable	S6-L-B11-3.0	S6-L-B11-5.0	S6-L-B11-10.0
	Incremental encoder cable	S6-L-P01-3.0	S6-L-P01-5.0	S6-L-P01-10.0
ISMH2-*****-A3***	Power cable	S6-L-B11-3.0	S6-L-B11-5.0	S6-L-B11-10.0
	Absolute encoder cable	S6-L-P21-3.0	S6-L-P21-5.0	S6-L-P21-10.0
ISMH3-*****-U1*** ISMH3-*****-U2*** (1.8 kW and below)	Power cable	S6-L-B11-3.0	S6-L-B11-5.0	S6-L-B11-10.0
	Incremental encoder cable	S6-L-P01-3.0	S6-L-P01-5.0	S6-L-P01-10.0
ISMH3-*****-A3*** (1.8 kW and below)	Power cable	S6-L-B11-3.0	S6-L-B11-5.0	S6-L-B11-10.0
	Absolute encoder cable	S6-L-P21-3.0	S6-L-P21-5.0	S6-L-P21-10.0
ISMH3-*****-U1*** ISMH3-*****-U2*** (2.9 kW)	Power cable	Power cable: prepared by customer		
	Incremental encoder cable	S6-L-P01-3.0	S6-L-P01-5.0	S6-L-P01-10.0
ISMH3-*****-A3*** (2.9 kW)	Power cable	Power cable: prepared by customer		
	Absolute encoder cable	S6-L-P21-3.0	S6-L-P21-5.0	S6-L-P21-10.0
ISMH3-*****-U1*** ISMH3-*****-U2*** (above 2.9 kW)	Power cable	Power cable: prepared by customer		
	Incremental encoder cable	S6-L-P01-3.0	S6-L-P01-5.0	S6-L-P01-10.0
ISMH3-*****-A3*** (above 2.9 kW)	Power cable	Power cable: prepared by customer		
	Absolute encoder cable	S6-L-P21-3.0	S6-L-P21-5.0	S6-L-P21-10.0

Note

The servo motor encoder cable includes CN1 connector; if you select Inovance matching cables, the connector kit is not required.

■ **Connector Kit**

Motor Model	Connector Kit
ISMH1-*****-U1*** ISMH1-*****-U2*** ISMH4-*****-U1*** ISMH4-*****-U2***	S6-C1 Including: CN1 terminal, CN2 terminal, 6-pin connector, 9-pin connector
ISMH1-*****-A3*** ISMH4-*****-A3***	
ISMH2-*****-U1*** ISMH2-*****-U2***	S6-C2 Including: CN1 terminal, CN2 terminal, 20-18 military spec. plug (elbow), 20-29military spec. plug (elbow)
ISMH2-*****-A3***	
ISMH3-*****-U1*** ISMH3-*****-U2*** ISMH3-*****-A3*** (1.8 kW and below)	S6-C2 Including: CN1 terminal, CN2 terminal, 20-18military spec. plug (elbow), 20-29military spec. plug (elbow)
ISMH3-*****-U1*** ISMH3-*****-U2*** ISMH3-*****-A3*** (2.9 kW)	S6-C3 Including: CN1 terminal, CN2 terminal, 20-22military spec. plug (elbow), 20-29military spec. plug (elbow)
ISMH3-*****-U1*** ISMH3-*****-U2*** ISMH3-*****-A3*** (2.9 kW and above)	

Note

If you prepare cables yourself rather than use Inonvace matching cables , the connector kit is required.

■ **Battery Kit of Absolute Encoder Motor**

If Inovance absolute encoder motor is used, the optional battery kit S6-C4 (battery, battery box) is required besides the matching cables.



Communication Cable

Cable Model	Description
S6-L-T00-3.0	Servo drive to PC communication cable
S6-L-T01-0.3	Communication cable for multi-drive parallel connection
S6-L-T02-2.0	Servo drive to PLC communication cable
S6-L-T03-0.0	Plug for termination resistor for servo drive communication

2.4.2 Cable Connectors

Servo Motor Cables

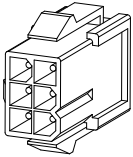
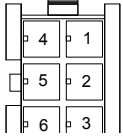
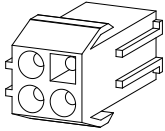
Table 2-8 Connectors of cables on servo motor side

Connector Appearance	Pin Layout	Frame Size of Matching Motor																					
	<p>Black 6-pin connector</p>  <table border="1" data-bbox="579 423 877 623"> <thead> <tr> <th>Pin No.</th> <th>Signal</th> <th>Color</th> </tr> </thead> <tbody> <tr> <td>1</td> <td>U</td> <td>White</td> </tr> <tr> <td>2</td> <td>V</td> <td>Black</td> </tr> <tr> <td>4</td> <td>W</td> <td>Red</td> </tr> <tr> <td>5</td> <td>PE</td> <td>Yellow/ Green</td> </tr> <tr> <td>3</td> <td>Brake (regardless of positive or negative)</td> <td></td> </tr> <tr> <td>6</td> <td></td> <td></td> </tr> </tbody> </table> <p>Recommendation: Plastic housing: MOLEX-50361736 Terminal: MOLEX-39000061</p>	Pin No.	Signal	Color	1	U	White	2	V	Black	4	W	Red	5	PE	Yellow/ Green	3	Brake (regardless of positive or negative)		6			<p>40 (Z series) 60 (Z series) 80 (Z series)</p>
Pin No.	Signal	Color																					
1	U	White																					
2	V	Black																					
4	W	Red																					
5	PE	Yellow/ Green																					
3	Brake (regardless of positive or negative)																						
6																							
	<p>4-pin connector</p>  <table border="1" data-bbox="506 802 884 951"> <thead> <tr> <th>Pin No.</th> <th>Signal</th> <th>Color</th> </tr> </thead> <tbody> <tr> <td>1</td> <td>U</td> <td>Blue</td> </tr> <tr> <td>2</td> <td>V</td> <td>Black</td> </tr> <tr> <td>3</td> <td>W</td> <td>Red</td> </tr> <tr> <td>4</td> <td>PE</td> <td>Yellow/Green</td> </tr> </tbody> </table> <p>Recommendation: Plastic housing: EL-4A (CWB) Terminal: 421.6003.0 (CWB)</p>	Pin No.	Signal	Color	1	U	Blue	2	V	Black	3	W	Red	4	PE	Yellow/Green	<p>40 (X series) 60 (X series) 80 (X series)</p>						
Pin No.	Signal	Color																					
1	U	Blue																					
2	V	Black																					
3	W	Red																					
4	PE	Yellow/Green																					

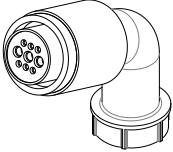
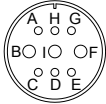
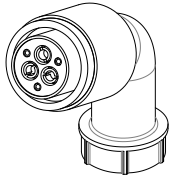
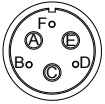
Connector Appearance	Pin Layout	Frame Size of Matching Motor																																						
	<p>MIL-DTL-5015 series 3108E20-18S military spec.</p> <p>20-18 military spec.</p>  <table border="1" data-bbox="386 435 865 727"> <thead> <tr> <th colspan="2">New Structure</th> <th colspan="2">Old Structure</th> <th rowspan="2">Color</th> </tr> <tr> <th>Pin No.</th> <th>Signal</th> <th>Pin No.</th> <th>Signal</th> </tr> </thead> <tbody> <tr> <td>B</td> <td>U</td> <td>B</td> <td>U</td> <td>Blue</td> </tr> <tr> <td>I</td> <td>V</td> <td>I</td> <td>V</td> <td>Black</td> </tr> <tr> <td>F</td> <td>W</td> <td>F</td> <td>W</td> <td>Red</td> </tr> <tr> <td>G</td> <td>PE</td> <td>G</td> <td>PE</td> <td>Yellow/ Green</td> </tr> <tr> <td>C</td> <td rowspan="2">Brake (regardless of positive or negative)</td> <td></td> <td></td> <td></td> </tr> <tr> <td>E</td> <td></td> <td></td> <td></td> </tr> </tbody> </table>	New Structure		Old Structure		Color	Pin No.	Signal	Pin No.	Signal	B	U	B	U	Blue	I	V	I	V	Black	F	W	F	W	Red	G	PE	G	PE	Yellow/ Green	C	Brake (regardless of positive or negative)				E				<p>100 130</p>
New Structure		Old Structure		Color																																				
Pin No.	Signal	Pin No.	Signal																																					
B	U	B	U	Blue																																				
I	V	I	V	Black																																				
F	W	F	W	Red																																				
G	PE	G	PE	Yellow/ Green																																				
C	Brake (regardless of positive or negative)																																							
E																																								
<p>2</p> 	<p>MIL-DTL-5015 series 3108E20-22S military spec.</p> <p>20-22 military spec.</p>  <table border="1" data-bbox="410 963 842 1239"> <thead> <tr> <th colspan="2">Y Series</th> <th colspan="2">Z Series</th> <th rowspan="2">Color</th> </tr> <tr> <th>Pin No.</th> <th>Signal</th> <th>Pin No.</th> <th>Signal</th> </tr> </thead> <tbody> <tr> <td>A</td> <td>U</td> <td>A</td> <td>U</td> <td>Blue</td> </tr> <tr> <td>C</td> <td>V</td> <td>C</td> <td>V</td> <td>Black</td> </tr> <tr> <td>E</td> <td>W</td> <td>E</td> <td>W</td> <td>Red</td> </tr> <tr> <td>F</td> <td>PE</td> <td>F</td> <td>PE</td> <td>Yellow/ Green</td> </tr> <tr> <td rowspan="2">D</td> <td></td> <td>B</td> <td rowspan="2">Brake (regardless of positive or negative)</td> <td rowspan="2"></td> </tr> <tr> <td></td> <td></td> </tr> </tbody> </table>	Y Series		Z Series		Color	Pin No.	Signal	Pin No.	Signal	A	U	A	U	Blue	C	V	C	V	Black	E	W	E	W	Red	F	PE	F	PE	Yellow/ Green	D		B	Brake (regardless of positive or negative)				<p>180</p>		
Y Series		Z Series		Color																																				
Pin No.	Signal	Pin No.	Signal																																					
A	U	A	U	Blue																																				
C	V	C	V	Black																																				
E	W	E	W	Red																																				
F	PE	F	PE	Yellow/ Green																																				
D		B	Brake (regardless of positive or negative)																																					

Note

1. Frame size of motor: indicates the width of motor flange.
2. The motor cable colors are subject to the actual. The cable colors mentioned in the manual are all Inovance cables.

Table 2-11 Connectors of 20-bit encoder cables (MIL-DTL-5015 series 3108E20-29S military spec. plug)

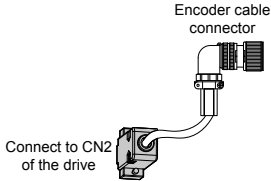
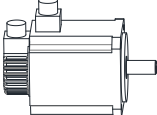
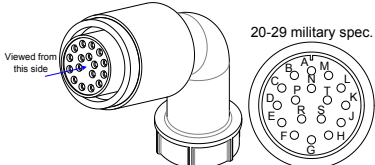
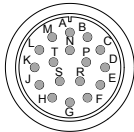
Connector Appearance and Pin Layout		Frame Size of Matching Motor																																		
																																				
 <table border="1" data-bbox="202 717 489 865"> <thead> <tr> <th>Pin No.</th> <th>Signal</th> <th></th> </tr> </thead> <tbody> <tr> <td>A</td> <td>PS+</td> <td rowspan="5">Twisted-pair</td> </tr> <tr> <td>B</td> <td>PS-</td> </tr> <tr> <td>G</td> <td>+5V</td> </tr> <tr> <td>H</td> <td>GND</td> </tr> <tr> <td>J</td> <td>Shielded</td> </tr> </tbody> </table>			Pin No.	Signal		A	PS+	Twisted-pair	B	PS-	G	+5V	H	GND	J	Shielded	 <table border="1" data-bbox="570 727 923 876"> <thead> <tr> <th>Pin No.</th> <th>Signal</th> <th>Color</th> <th></th> </tr> </thead> <tbody> <tr> <td>A</td> <td>PS+</td> <td>Yellow</td> <td rowspan="5">Twisted-pair</td> </tr> <tr> <td>B</td> <td>PS-</td> <td>Blue</td> </tr> <tr> <td>G</td> <td>+5V</td> <td>Red</td> </tr> <tr> <td>H</td> <td>GND</td> <td>White</td> </tr> <tr> <td>J</td> <td>Shielded</td> <td></td> </tr> </tbody> </table>	Pin No.	Signal	Color		A	PS+	Yellow	Twisted-pair	B	PS-	Blue	G	+5V	Red	H	GND	White	J	Shielded
Pin No.	Signal																																			
A	PS+	Twisted-pair																																		
B	PS-																																			
G	+5V																																			
H	GND																																			
J	Shielded																																			
Pin No.	Signal	Color																																		
A	PS+	Yellow	Twisted-pair																																	
B	PS-	Blue																																		
G	+5V	Red																																		
H	GND	White																																		
J	Shielded																																			
		100 130 180																																		

2

Table 2-12 Pin connection relation of IS620P series 20-bit encoder cables

DB9 on Servo Drive Side		Function Description	Motor Side	
Signal	Pin No.		9-pin Pin No.	20-29 Military Spec. Pin No.
PS+	1	Serial communication signal +	3	A
PS-	2	Serial communication signal -	6	B
+5V	7	Encoder +5V power supply	9	G
GND	8	Encoder +5V power ground	8	H
PE	Housing	Shield	7	J

Observe the following precautions when wiring the encoder:

- Ground the servo drive and shielded layer of the servo motor reliably. Otherwise, the servo drive will report a false alarm.
- Do not connect cables to the reserved pins.
- To determine the length of the encoder cable, consider voltage drop caused by the cable resistance and signal attenuation caused by the distributed capacitance. It is recommended to use twisted-pair cable of size 26AWG or above (as per UL2464 standard) and with a length within 10 m.

Table 2-13 Recommended cable sizes

Cable Size	Ω/km	Allowed Cable Length (m)
26AWG (0.13 mm ²)	143	10.0
25AWG (0.15 mm ²)	89.4	16.0
24AWG (0.21 mm ²)	79.6	18.0
23AWG (0.26 mm ²)	68.5	20.9
22AWG (0.32 mm ²)	54.3	26.4

Note

If the cables of above 22AWG are required, contact Inovance.

■ **Absolute Encoder**

Table 2-14 Connectors of absolute encoder cables (9-pin connector)

Connector Appearance and Pin Layout		Frame Size of Matching Motor																																																					
<p>Connect to CN2 of the drive</p>		<p>40 60 80</p>																																																					
<p>Viewed from this side</p>	<p>Viewed from this side</p>																																																						
<table border="1"> <thead> <tr> <th>Pin No.</th> <th>Signal</th> <th></th> </tr> </thead> <tbody> <tr> <td>1</td> <td>Battery+</td> <td></td> </tr> <tr> <td>4</td> <td>Battery-</td> <td></td> </tr> <tr> <td>3</td> <td>PS+</td> <td rowspan="2">Twisted-pair</td> </tr> <tr> <td>6</td> <td>PS-</td> </tr> <tr> <td>9</td> <td>+5V</td> <td></td> </tr> <tr> <td>8</td> <td>GND</td> <td></td> </tr> <tr> <td>7</td> <td>Shield</td> <td></td> </tr> </tbody> </table> <p>Recommendation: Plastic housing: AMP 172161-1 Terminal: AMP 770835-1</p>	Pin No.		Signal		1	Battery+		4	Battery-		3	PS+	Twisted-pair	6	PS-	9	+5V		8	GND		7	Shield		<table border="1"> <thead> <tr> <th>Pin No.</th> <th>Signal</th> <th>Color</th> <th></th> </tr> </thead> <tbody> <tr> <td>1</td> <td>Battery+</td> <td>Blue</td> <td></td> </tr> <tr> <td>4</td> <td>Battery-</td> <td>Blue black</td> <td></td> </tr> <tr> <td>3</td> <td>PS+</td> <td>Yellow</td> <td rowspan="2">Twisted-pair</td> </tr> <tr> <td>6</td> <td>PS-</td> <td>Yellow black</td> </tr> <tr> <td>9</td> <td>+5V</td> <td>Red</td> <td></td> </tr> <tr> <td>8</td> <td>GND</td> <td>Black</td> <td></td> </tr> <tr> <td>7</td> <td>Shield</td> <td></td> <td></td> </tr> </tbody> </table>	Pin No.	Signal	Color		1	Battery+	Blue		4	Battery-	Blue black		3	PS+	Yellow	Twisted-pair	6	PS-	Yellow black	9	+5V	Red		8	GND	Black		7	Shield	
Pin No.	Signal																																																						
1	Battery+																																																						
4	Battery-																																																						
3	PS+	Twisted-pair																																																					
6	PS-																																																						
9	+5V																																																						
8	GND																																																						
7	Shield																																																						
Pin No.	Signal	Color																																																					
1	Battery+	Blue																																																					
4	Battery-	Blue black																																																					
3	PS+	Yellow	Twisted-pair																																																				
6	PS-	Yellow black																																																					
9	+5V	Red																																																					
8	GND	Black																																																					
7	Shield																																																						

2

Table 2-15 Connectors of absolute encoder cables (MIL-DTL-5015 series 3108E20-29S military spec. plug)

Connector Appearance and Pin Layout		Frame Size of Matching Motor																																																						
<table border="1"> <thead> <tr> <th>Pin No.</th> <th>Signal</th> <th></th> </tr> </thead> <tbody> <tr> <td>A</td> <td>PS+</td> <td rowspan="2">Twisted-pair</td> </tr> <tr> <td>B</td> <td>PS-</td> </tr> <tr> <td>E</td> <td>Battery+</td> <td></td> </tr> <tr> <td>F</td> <td>Battery-</td> <td></td> </tr> <tr> <td>G</td> <td>+5V</td> <td></td> </tr> <tr> <td>H</td> <td>GND</td> <td></td> </tr> <tr> <td>J</td> <td>Shield</td> <td></td> </tr> </tbody> </table>		Pin No.	Signal		A	PS+	Twisted-pair	B	PS-	E	Battery+		F	Battery-		G	+5V		H	GND		J	Shield		<p>20-29 military spec.</p> <table border="1"> <thead> <tr> <th>Pin No.</th> <th>Signal</th> <th>Color</th> <th></th> </tr> </thead> <tbody> <tr> <td>A</td> <td>PS+</td> <td>Yellow</td> <td rowspan="2">Twisted-pair</td> </tr> <tr> <td>B</td> <td>PS-</td> <td>Yellow black</td> </tr> <tr> <td>E</td> <td>Battery+</td> <td>Blue</td> <td></td> </tr> <tr> <td>F</td> <td>Battery-</td> <td>Blue black</td> <td></td> </tr> <tr> <td>G</td> <td>+5V</td> <td>Red</td> <td></td> </tr> <tr> <td>H</td> <td>GND</td> <td>Black</td> <td></td> </tr> <tr> <td>J</td> <td>Shield</td> <td></td> <td></td> </tr> </tbody> </table>	Pin No.	Signal	Color		A	PS+	Yellow	Twisted-pair	B	PS-	Yellow black	E	Battery+	Blue		F	Battery-	Blue black		G	+5V	Red		H	GND	Black		J	Shield		
Pin No.	Signal																																																							
A	PS+	Twisted-pair																																																						
B	PS-																																																							
E	Battery+																																																							
F	Battery-																																																							
G	+5V																																																							
H	GND																																																							
J	Shield																																																							
Pin No.	Signal	Color																																																						
A	PS+	Yellow	Twisted-pair																																																					
B	PS-	Yellow black																																																						
E	Battery+	Blue																																																						
F	Battery-	Blue black																																																						
G	+5V	Red																																																						
H	GND	Black																																																						
J	Shield																																																							
		<p>100</p> <p>130</p> <p>180</p>																																																						

Chapter 3 Operation and Display

3.1 Introduction to Keypad

Figure 3-1 Diagram of the keypad

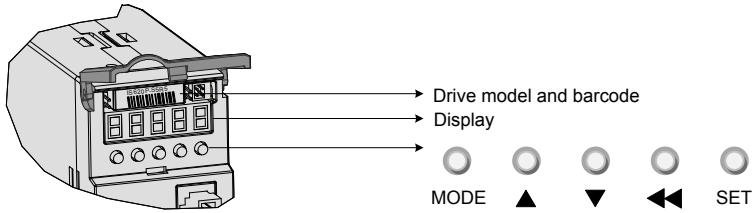

The keypad on the servo drive consists of the 5-digit 7-segment LEDs and keys. The keypad is used for display, parameter setting, user password setting and general functions operations. When the keypad is used for parameter setting, the functions of the keys are described as follows.

Table 3-1 Functions of keys on the keypad

Key Name	Function Description
MODE	Switch between all modes. Return to the upper-level menu.
UP	Increase the number indicated by the blinking digit.
DOWN	Decrease the number indicated by the blinking digit.
SHIFT	Shift the blinking digit. View the high digits of the number consisting of more than 5 digits.
SET	Switch to the next-level menu. Execute commands such as storing parameter setting value.

3.2 Keypad Display

The keypad can display the running status, parameter, faults, and monitored information during running of the servo drive.

- Status display: Displays the current servo drive status, such as servo ready or running.
- Parameter display: Displays function codes and their values.
- Fault display: Displays the fault and warnings occurring in the servo drive.
- Monitoring display: Displays the current running parameters of the servo drive.

3.2.1 Display Switchover

Figure 3-2 Switching between different display

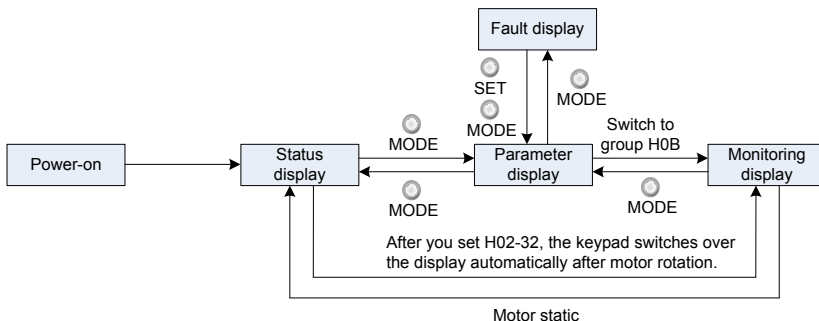

- After the power is on, the keypad enters the status display mode.
- Press key MODE to switch over between different modes, as shown in the preceding figure.
- In status display mode, set H02-32 and select the monitored parameters. When the motor rotates, the keypad automatically switches over to monitoring display. After the motor becomes stopped, the keypad automatically restores to status display.
- In parameter display mode, set group H0B and select the parameters to be monitored, and the keypad switches over to the monitoring display mode.
- Once a fault occurs, the keypad immediately enters the fault display mode, and all 5-digit LEDs blink. Press key SET to stop blinking, and then press key MODE to switch over to the parameter display mode.

3.3 Parameter Setting

3

Parameter setting can be performed on the keypad. For details on the parameters, refer to the IS620P User Manual. The following figure shows the keypad operation of switching the position control mode to the speed control mode after the power is on.

Figure 3-3 Keypad operation of parameter setting

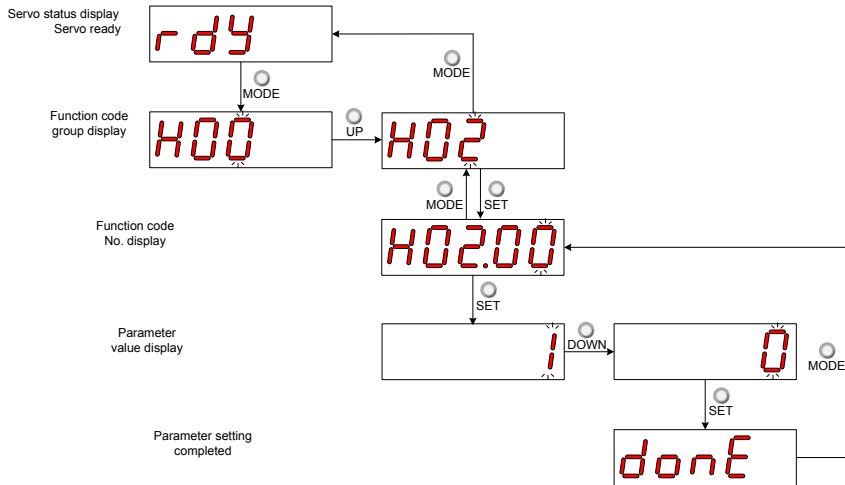

- MODE: Switch the display mode and return to the upper-level menu.
- UP/DOWN: Increase or decrease the value of the current blinking digit.
- SHIFT: Shifting the blinking digit.
- SET: Store the current setting value or switch to the next-level menu.

After parameter setting is completed, that is, "Done" is displayed, press key MODE to return to the parameter group display (H02-00).

3.4 User Password

After the user password function (H02-30) is enabled, only the authorized user has the parameter setting rights; other operations can only view the parameters.

Setting User Password

The following figure shows the operation procedure of setting the password to "00001".

Figure 3-4 Keypad operation of user password setting

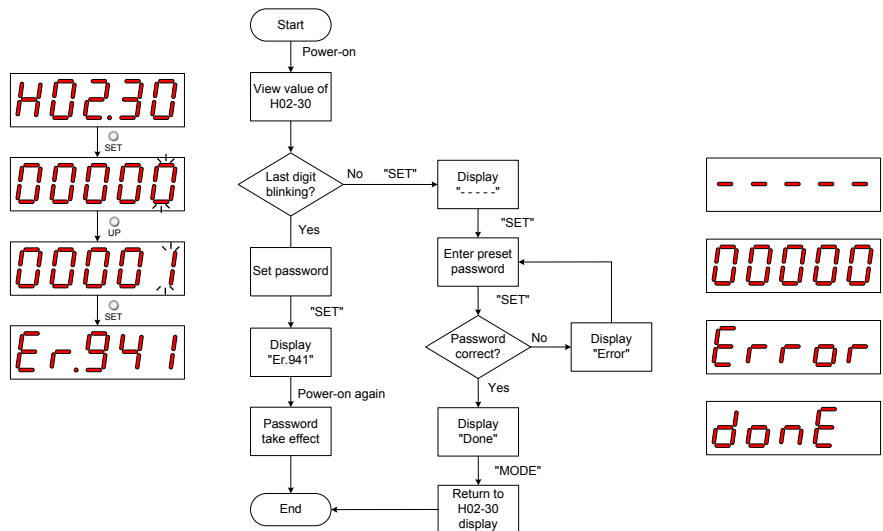

Note *1: If the last digit does not blink, password protection is enabled. If the last digit blinks, password protection is disabled or the correct password has been entered.

When modifying the user password, enter the correct password so that you have the rights of parameter setting. Enter H02-30 again, and you can set a new password according to the method described in the preceding figure.

Canceling User Password

Enter the existing user password, and set H02-30 to "00000". Then, the user password is cancelled.

Chapter 4 Quick Setup

The following part shows the quick setup flowchart.

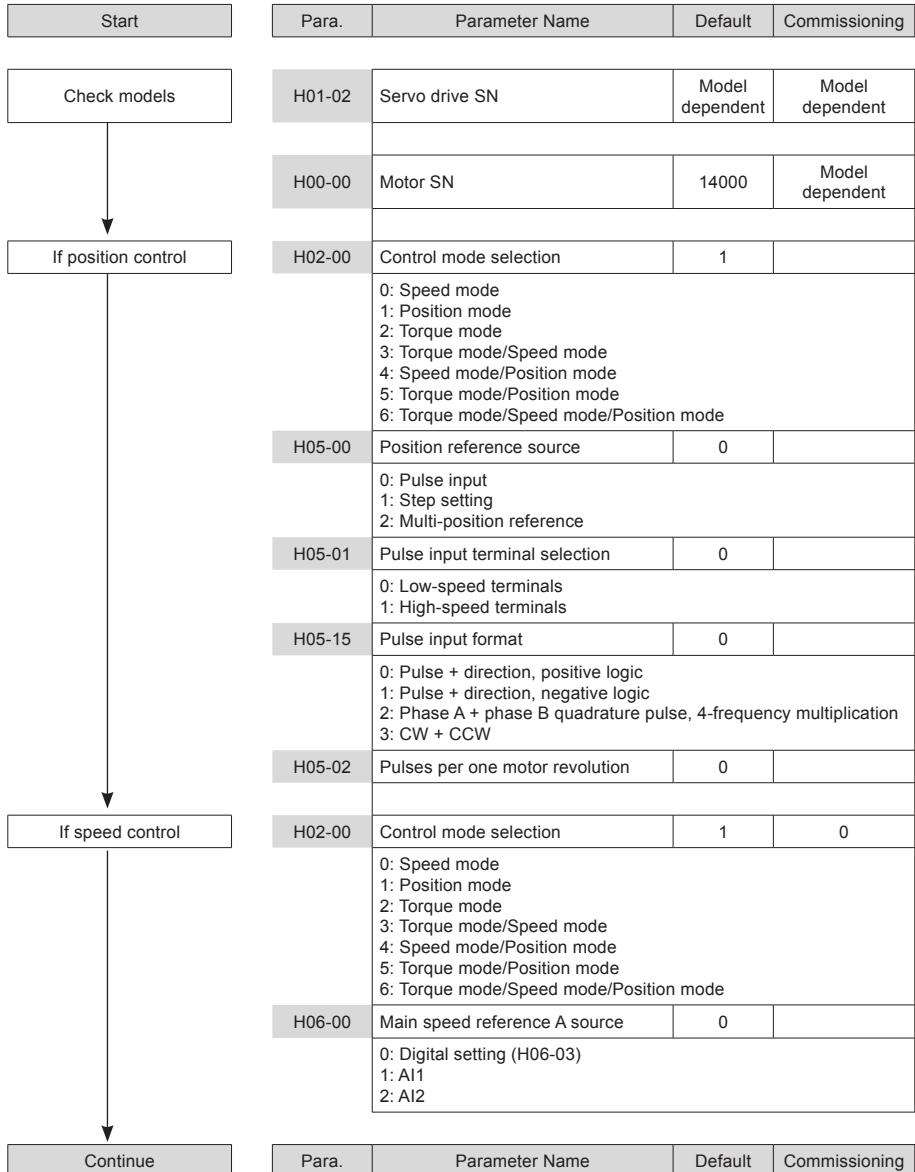

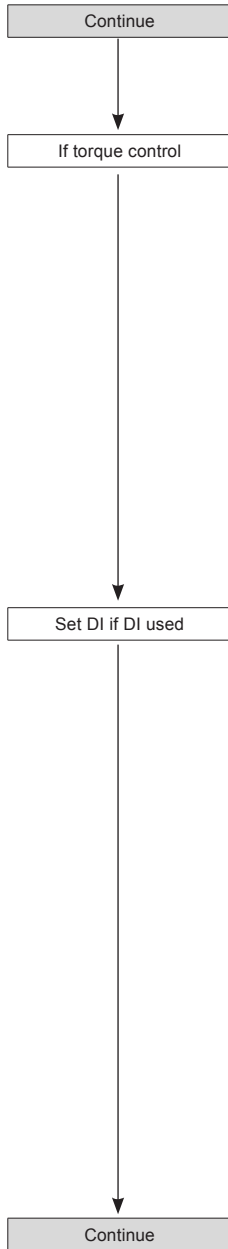

Para.	Parameter Name	Default	Commissioning
H06-07	Maximum speed limit	6000	
H02-00	Control mode selection	1	2
	0: Speed mode 1: Position mode 2: Torque mode 3: Torque mode/Speed mode 4: Speed mode/Position mode 5: Torque mode/Position mode 6: Torque mode/Speed mode/Position mode		
H07-00	Main torque reference A source	0	
	0: Digital setting (H07-03) 1: AI1 2: AI2		
H07-19	Positive speed limit/1st speed limit in torque control	3000	
H07-20	Negative speed limit/2nd speed limit in torque control	3000	
H03-02	DI1 function selection	14	
	14: P-OT (Forward limit switch)		
H03-03	DI1 logic selection	0	
	0: Low level valid 1: High level valid 2: Rising edge valid 3: Falling edge valid 4: Rising edge and falling edge both valid		
H03-04	DI2 function selection	15	
	15: P-OT (Reverse limit switch)		
H03-05	DI2 logic selection	0	
H03-06	DI3 function selection	13	
	13: INHIBIT (Position reference inhibited)		
H03-07	DI3 logic selection	0	
H03-08	DI4 function selection	2	
	2: ALM-RST (Fault and warning reset)		
Para.	Parameter Name	Default	Commissioning

4

Continue

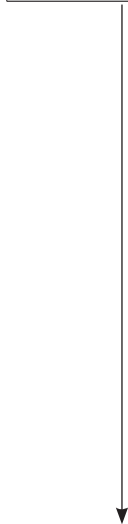

Set AI1 if used as speed reference



Set AI2 if used as speed reference



Continue

Para.	Parameter Name	Default	Commissioning
H03-09	DI4 logic selection 1: S-ON (Servo ON)	0	
H03-10	DI5 function selection	1	
H03-11	DI5 logic selection	0	
.....		
H03-16	DI8 function selection 31: HomeSwitch (Home switch)	31	
H03-17	DI8 logic selection	0	
H03-18	DI9 function selection 0: No function	0	
H03-19	DI9 logic selection	0	
H03-80	Speed corresponding to 10 V 0 to 6000 RPM	3000	
H03-54	AI1 zero drift	0	
H03-53	AI1 dead zone	10	
H03-51	AI1 filter time constant	10	
H03-80	Speed corresponding to 10 V 0 to 6000 RPM	3000	
H03-59	AI2 zero drift	0	
H03-58	AI2 dead zone	10	
H03-56	AI2 filter time constant	10	
Para.	Parameter Name	Default	Commissioning

Continue

Set AI1 if used as torque reference



Set AI2 if used as torque reference



Set DO if DO used



Continue

Para.	Parameter Name	Default	Commissioning
H03-81	Torque corresponding to 10 V 1.0 to 8.0 times of rated torque	1	
H03-54	AI1 zero drift	0	
H03-53	AI1 dead zone	10	
H03-51	AI1 filter time constant	10	
H03-81	Torque corresponding to 10 V 1.0 to 8.0 times of rated torque	1	
H03-59	AI2 zero drift	0	
H03-58	AI2 dead zone	10	
H03-56	AI2 filter time constant	10	
H04-01	DO1 function selection 1: S-RDY (Servo ready)	1	
H04-02	DO1 logic selection 0: Output low level when valid (optocoupler ON) 1: Output high level when valid (optocoupler OFF)	0	
H04-03	DO2 function selection 5: COIN (Positioning completed)	5	
H04-04	DO2 logic selection	0	
H04-05	DO3 function selection 3: ZERO (Zero speed signal)	3	
H04-06	DO3 logic selection	0	

Para.	Parameter Name	Default	Commissioning
-------	----------------	---------	---------------

4

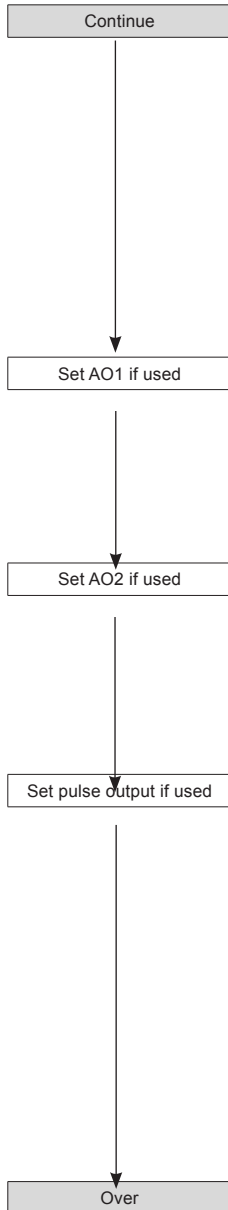

Para.	Parameter Name	Default	Commissioning
H04-07	DO4 function selection	11	
	11: ALM (Fault output)		
H04-08	DO4 logic selection	0	
H04-09	DO5 function selection	16	
	16: Home Attain (Home attaining output)		
H04-10	DO5 logic selection	0	
H04-50	AO1 signal selection	0	
	0: Motor speed		
H04-51	AO1 offset voltage	5000	
H04-52	AO1 multiplying factor	1	
H04-53	AO2 signal selection	1	
	1: Speed reference		
H04-54	AO2 offset voltage	5000	
H04-55	AO2 multiplying factor	1	
H05-38	Servo pulse output source	0	0 or 1
	0: Encoder frequency-division output 1: Pulse synchronous output 2: Frequency-division or synchronous output inhibited		
H05-17	Encoder frequency-division pulses	2500 p/r	
	35 to 32767		
H02-03	Output pulse phase	0	
	0: CCW direction as forward direction (phase A advancing phase B) 1: CW direction as forward direction (phase A lagging phase B)		
H05-41	Output polarity of Z pulse	0	
	0: Positive (high level when pulse Z is valid) 1: Negative (low level when pulse Z is valid)		

Chapter 5 Troubleshooting

5.1 During Startup

5.1.1 Position Control

During Startup	Fault Symptom	Cause	Confirming Methods
Connect control power L1C/L2C and main power L1/L2 and R/S/T.	The LED display is not on or does not display "rdy".	1. The control power voltage is abnormal.	After disconnecting CN1, CN2, CN3 and CN4, the fault persists. Measure AC voltage between L1C and L2C.
		2. The main power voltage is abnormal.	For single-phase 220 V model, measure AC voltage between L1 and L2. When DC bus voltage amplitude (voltage between P _b and ⊖) is lower than 200 V, "nrd" is displayed. For three-phase 220/380 V model, measure AC voltage between R, S and T. When DC bus voltage amplitude (voltage between P _b and ⊖) is lower than 460 V, "nrd" is displayed.
		3. The program burning terminal is shorted.	Check whether the program burning terminal is shorted.
		4. The servo drive is faulty.	-
	The operation panel displays "Er. xxx".	Remove the fault.	
After the preceding causes are removed, the operation panel should display "rdy".			
Set the S-ON signal to ON.	The operation panel displays "Er. xxx".	Remove the fault.	
	Shaft of the servo motor is in free running status.	1. The S-ON signal is invalid.	Set operation panel to servo status display and view whether the operation panel displays "rdy" rather than "run". Check whether any parameter in groups H03 and H17 is set for FunIN1(S-ON). If yes, check that the corresponding DI is set to ON. If not, allocate the function and set the corresponding DI to ON. See group H03 in Chapter 7 for details on setting of input terminal parameters. If a parameter in group H03 has been set for FunIN1(S-ON) and corresponding DI is ON, but the operation panel still displays "rdy". In this case, check whether the DI terminal is connected correctly by referring to Chapter 3 in the IS620P User Manual.
		2. Selection of control mode is incorrect.	Check whether H02-00 is set to 1. If it is set to 2 (torque mode), motor shaft must be in free running status because default torque reference is 0.
After the preceding causes are removed, the operation panel should display "run".			

During Startup	Fault Symptom	Cause	Confirming Methods
Input position reference.	Servo motor does not rotate.	Input reference pulse counter (H0B-13) is 0.	<p>High/low-speed pulse input terminal is wired incorrectly.</p> <p>When H05-00 = 0 (pulse is main position reference source), check whether high/low-speed pulse input terminal is wired correctly by referring to Chapter 3 in the IS620P User Manual. Meanwhile, check whether the setting of H05-01(reference pulse selection) is matched.</p> <p>Position reference is not input.</p> <ol style="list-style-type: none"> 1. Check whether FunIN.13: INHIBIT (pulse input forbidden) or FunIN.37: PulseInhibit (pulse forbidden) is used. 2. When H05-00 = 0 (pulse is main position reference source), host computer or other pulse generator does not output pulses. Check whether there are pulses into high/low-speed pulse input terminal. Please refer to the IS620P User Manual. 3. When H05-00 = 1 (step reference is main position reference source), check whether H05-05 (step amount) is 0. If not, check whether FunIN.20: PosStep (DI position step reference) has been allocated and whether logic of corresponding terminal is valid. <p>When H05-00 = 2 (multi-position reference is main position reference source), check whether parameters in group H11 are set correctly. If yes, , check whether FunIN.28: PosInSen (internal multi-position enable) has been allocated and whether logic of corresponding terminal is valid.</p> <ol style="list-style-type: none"> 5. If position change on fly is used, check whether H05-29 (position change on fly unlock) is set to 1(enabled). If yes, check whether FunIN.29: XintFree (position change on fly unlocked) is used.
	Servo motor rotates in reverse direction.	Input reference pulse counter (H0B-13) is negative.	<p>When H05-00 = 0 (pulse is main position reference source), check whether the setting of H05-15 (reference pulse form) is consistent with actual pulse input. If not, it indicates that H05-15 is set incorrectly or terminal wiring is incorrect.</p> <p>When H05-00 = 1 (step reference is main position reference source), check whether H05-05 (step amount) is positive or negative.</p> <p>When H05-00 = 2 (multi-position reference is main position reference source), check whether each displacement is positive or negative.</p> <p>When H05-00 = 2 (multi-position reference is main position reference source), check whether each displacement is positive or negative.</p> <p>Check whether H02-02 (rotation direction selection) is set correctly.</p>
Servo motor can rotate after preceding fault is removed.			

During Startup	Fault Symptom	Cause	Confirming Methods
Servo motor jitters at low speed.	Motor speed is not steady.	The gain is set improperly.	Perform automatic gain tuning.
	Motor shaft vibrates left and right.	The load inertia ratio (H08-15) is too large.	If servo motor can run safely, perform inertia auto-tuning and perform automatic gain tuning.
	After preceding causes are removed, servo motor can operate normally.		
Servo system runs normally.	Positioning inaccurate	Unsatisfactory position deviation is generated.	Confirm input reference pulse counter (H0B-13), feedback pulse counter (H0B-17) and mechanical stop position according to the following steps.

5.1.2 Speed Control

During Startup	Fault Symptom	Cause	Confirming Methods
Connect control power L1C/L2C and main power L1/L2 and R/S/T.	The LED display is not on or does not display "rdy".	1. Control power voltage is abnormal.	After disconnecting CN1, CN2, CN3 and CN4, the fault persists. Measure AC voltage between L1C and L2C.
		2. Main power voltage is abnormal.	For single-phase 220 V mode, measure AC voltage between L1 and L2. When DC bus voltage amplitude (voltage between P ₊ and ⊖) is lower than 200 V, "nrd" is displayed. For three-phase 220/380 V model, measure AC voltage between R, S and T. When DC bus voltage amplitude (voltage between P ₊ and ⊖) is lower than 460V, "nrd" is displayed.
		3. The program burning terminal is shorted.	Check whether the program burning terminal is shorted.
		4. The servo drive is faulty.	-
	The operation panel displays "Er. xxx".	Remove the fault.	
	After the preceding causes are removed, the operation panel should display "rdy".		

During Startup	Fault Symptom	Cause	Confirming Methods
Set the S-ON signal to ON.	The operation panel displays "Er. xxx".	Remove the fault.	
	Shaft of the servo motor is in free running status.	1. The S-ON signal is invalid.	Set operation panel to servo status display and view whether the operation panel displays "rdy" rather than "run". Check whether any parameter in groups H03 and H17 is set for FunIN1(S-ON). If yes, check that the corresponding DI is set to ON. If not, allocate the function and set the corresponding DI to ON. See group H03 in Chapter 7 for details on setting of input terminal parameters. If a parameter in group H03 has been set for FunIN1(S-ON) and logic of corresponding DI is logic, but the operation panel still displays "rdy". In this case, check whether the DI terminal is connected correctly by referring to Chapter 3 in the IS620P User Manual.
		2. Selection of control mode is incorrect.	Check whether H02-00 is set to 0. If it is set to 2 (torque mode), motor shaft must be in free running status because default torque reference is 0.
	After the preceding causes are removed, the operation panel should display "run".		
Input speed reference	Servo motor does not rotate or the motor speed is abnormal.	Speed reference (H0B-01) is 0.	AI wiring is incorrect. When speed reference is input from AI, check whether the analog input channel is selected correctly and check whether the selected AI terminal is wired correctly by referring to Chapter 3 in the IS620P User Manual. Speed reference selection is incorrect. Check whether H06-02 (speed reference selection) is set correctly. Speed reference is not input or is abnormal. 1. When AI is selected to input speed reference, check whether AI related parameters in group H03 are set correctly first. Then check whether input voltage is correct by observing voltage on oscilloscope or viewing AI sampling voltage in H0B-21 or H0B-22. 2. When digital setting is used to set speed reference, check whether H06-03 (keypad setting value of speed reference) is set correctly. 3. When multi-speed is used to set speed reference, check whether the parameters in group H12 are set correctly. 4. When serial comms. is used to set speed reference, check whether H31-09 (speed reference set via communication) is set correctly. 5. When jog speed reference is used to set speed reference, check whether H06-04 (jog speed setting value) is set correctly, whether DI functions FunIN.18: JOGCMD+ (forward jog) and FunIN.19: JOGCMD- (reverse jog) have been allocated and whether logic of corresponding DIs is valid. 6. Check whether H06-05 (acceleration ramp time constant of speed reference) and H06-06 (deceleration ramp time constant of speed reference) are set correctly. 7. Check whether the DI function FunIN.12: ZCLAMP (zero speed clamp function) is misallocated and whether valid logic of corresponding DI is corrected.

During Startup	Fault Symptom	Cause	Confirming Methods
Input speed reference	Servo motor rotates in reverse direction.	Speed reference (H0B-01) is negative.	<p>1. When AI is selected to input speed reference, check whether polarity of input signal is reverse.</p> <p>2. When digital setting is used to set speed reference, check whether H06-03 (keypad setting value of speed reference) is smaller than 0.</p> <p>3. When multi-speed is used to set speed reference, check whether speed references in group H12 are positive or negative.</p> <p>4. When serial comms. is used to set speed reference, check whether H31-09 (speed reference set via communication) is smaller than 0.</p> <p>When jog speed reference is used to set speed reference, check value of H06-04 (jog speed setting value). Then check whether effective logic of DI functions FunIN.18: JOGCMD+ (forward jog) and FunIN.19: JOGCMD- (reverse jog) matches the predicted rotating direction.</p> <p>Check whether DI function FunIN.26: SpdDirSel (speed reference direction) has been allocated and whether logic of corresponding DI is valid.</p> <p>Check whether H02-02 (rotation direction selection) is set correctly.</p>
	Servo motor can rotate after preceding fault is removed.		
Servo motor jitters at low speed.	Motor speed is not steady.	The gain is set unreasonably.	Perform automatic gain tuning.
	Motor shaft vibrates left and right.	The load inertia ratio (H08-15) is too large.	If servo motor can run safely, perform inertia auto-tuning and perform automatic gain tuning.

5.1.3 Torque Control

During Startup	Fault Symptom	Cause	Confirming Methods
Connect control power L1C/L2C and main power L1/L2 and R/S/T.	The LED display is not on or does not display Rdy.	1. The control power voltage is abnormal.	After disconnecting CN1, CN2, CN3 and CN4, the fault persists. Measure AC voltage between L1C and L2C.
		2. The main power voltage is abnormal.	For single-phase 220 V mode, measure AC voltage between L1 and L2. When DC bus voltage amplitude (voltage between P ₊ and ⊖) is lower than 200 V, "nrd" is displayed. For three-phase 220/380 V model, measure AC voltage between R, S and T. When DC bus voltage amplitude (voltage between P ₊ and ⊖) is lower than 460V, "nrd" is displayed.
		3. The program burning terminal is shorted.	Check whether the program burning terminal is shorted.
		4. The servo drive is faulty.	-
	The operation panel displays "Er. xxx".	Remove the fault.	
After the preceding causes are removed, the operation panel should display "rdy".			
Set the S-ON to ON.	The operation panel displays "Er. xxx".	Remove the fault.	
	Shaft of the servo motor is in free running status.	1. The S-ON signal is invalid.	Set operation panel to servo status display and view whether the operation panel displays "rdy" rather than "run". Check whether any parameter in groups H03 and H17 is set for FunIN1(S-ON). If yes, check that the corresponding DI is set to ON. If not, allocate the function and set the corresponding DI to ON. See group H03 in Chapter 7 for details on setting of input terminal parameters. If a parameter in group H03 has been set for FunIN1(S-ON) and logic of corresponding DI is logic, but the operation panel still displays "rdy". In this case, check whether the DI terminal is connected correctly by referring to Chapter 3 in the IS620P User Manual.
	After the preceding causes are removed, the operation panel should display "run".		

During Startup	Fault Symptom	Cause	Confirming Methods
Input torque reference	Servo motor does not rotate.	Internal torque reference (H0B-02) is 0.	<p>AI wiring is incorrect.</p> <p>When AI is selected to input torque reference, check whether polarity of input signal is reverse.</p> <p>Selection of torque reference is incorrect.</p> <p>Check whether H07-02 (torque reference source) is set correctly.</p> <p>Torque reference is not input.</p> <ol style="list-style-type: none"> When AI is selected to input torque reference, check whether AI related parameters in group H03 are set correctly first. Then check whether input voltage is correct by observing voltage on oscilloscope or reading the value of H0B-21 or H0B-22. When digital setting is used to set torque reference, check whether H07-03 (keypad setting value of torque reference) is set correctly. When serial comms. is used to set torque reference, check whether H31-11 (torque reference set via communication) is set correctly.
	Servo motor rotates in reverse direction.	Internal torque reference (H0B-02) is negative.	<ol style="list-style-type: none"> When AI is selected to input torque reference, check whether polarity of external voltage input signal is reverse. You can confirm it by using an oscilloscope or viewing H0B-21 or H0B-22. When digital setting is used to set torque reference, check whether H07-03 (keypad setting value of torque reference) is smaller than 0. When serial comms. is used to set torque reference, check whether H31-11 (torque reference set via communication) is smaller than 0. Check whether DI function FunIN.25: ToqDirSel (torque reference direction) has been allocated and whether logic of corresponding DI is valid. Check whether H02-02 (rotation direction selection) is set correctly.
Servo motor can rotate after preceding fault is removed.			
Servo motor jitters at low speed.	Motor speed is not steady.	The gain is set unreasonably.	Perform automatic gain tuning.
	Motor shaft vibrates left and right.	The load inertia ratio (H08-15) is too large.	If servo motor can run safely, perform inertia auto-tuning and perform automatic gain tuning.

5.2 During Running

5.2.2 Troubleshooting of Faults

Er.101: Groups H02 and above parameters abnormal

Cause	Confirming Methods	Corrective Action
1. The control power voltage drops instantaneously.	Check whether it is in the process of cutting off control power (L1C, L2C) or whether instantaneous power failure occurs.	Restore default setting (H02-31 = 1), and write the parameters again.
	Measure whether the control power voltage on the non-drive side is within the following specifications: 220 V AC drive: Valid value: 220 to 240 V Allowed error: -10% to 10% (198 to 264 V) 380V AC drive: Valid value 380 to 480 V Allowed error: -10% to 10% (342 to 528 V)	Increase power capacity or replace with large-capacitance power supply, restore default setting (H02-31 = 1), and write the parameters again.
2. Instantaneous power failure occurs during parameter storage.	Check whether instantaneous power failure occurs during parameter storage.	Re-power on the system, restore default setting (H02-31 = 1), and write the parameters again.
3. The times of parameter writing within a certain period exceeds the limit.	Check whether parameter update is performed frequently from the host controller.	Change parameter writing method and write parameters again. If servo drive is faulty, replace it
4. The software is upgraded.	Check whether software is upgraded.	Set servo drive model and servo motor model again, and restore default setting (H02-31 = 1).
5. The servo drive is faulty.	If the fault persists after you power on servo drive several times and restore default setting, it indicates that the servo drive is faulty.	Replace the servo drive.

Er.102: Programmable logic configuration fault

Cause	Confirming Methods	Corrective Action
1. The FPGA software version and the MCU software version do not match.	View the MCU software version (H1-00) and the FPGA software version (H1-01) via operating panel or drive debugging platform of Inovance. Check whether the non-zero numbers of the most significant bit of the versions are consistent.	Contact Inovance for technical support. Update matching FPGA or MCU software.
2. The FPGA is faulty.	The fault persists after you power on the servo drive several times.	Replace the servo drive.

5

Er.104: Programmable logic interruption

Cause	Confirming Methods	Corrective Action
1. The FPGA is faulty (E4.104).	The fault persists after you power on the servo drive several times.	Replace the servo drive.
2. The communication between the FPGA and the MCU is abnormal (Er.100).		
3. The drive internal operation times out (Er.940).		

Er.105: Internal program abnormal

Cause	Confirming Methods	Corrective Action
1. An EEPROM fault occurs.	Check causes according to the method of Er.101.	Restore default setting (H02-31 = 1), and power on the servo drive again.
2. The servo drive is faulty.	The fault persists after you power on servo drive several times.	Replace the servo drive.

Er.108: Parameter storage fault

Cause	Confirming Methods	Corrective Action
1. EEPROM writing is abnormal.	Modify a parameter, power on servo drive again, and check whether modification is saved.	If modification is not saved and the fault persists after servo drive is powered on several times, replace the servo drive.
2. EEPROM reading is abnormal.		

Er.120: Product model matching fault

Cause	Confirming Methods	Corrective Action
1. Product (motor or servo drive) SN does not exist.	View servo drive and servo motor nameplates to check that the equipment you are using is IS620P series servo drive and 20-bit servo motor (-U2***) of Inovance. Meanwhile, check whether H00-00 (Motor SN) is 14000.	Servo motor SN does not exist. If you use IS620P series servo drive and 20-bit servo motor (-U2***) of Inovance, ensure that H00-00 = 14000.
	View servo drive SN (H01-02) and check whether servo drive SN exists.	Servo drive SN does not exist. Set servo drive SN correctly.
Power class of servo motor and servo drive does not match.	Check whether servo drive SN (H01-02) and serial encoder motor SN (H00-05) match.	Replace unmatched product.

Er.121: S-ON signal invalid

Cause	Confirming Methods	Corrective Action
When servo drive is enabled internally, external S-ON signal is valid.	Check whether auxiliary functions (H0D-02, H0D-03, H0D-12) are used and whether DI function FunIN.1: S-ON is ON.	Set DI function FunIN.1: S-ON (both hardware DI and virtual DI) to OFF.

Er.122: Product matching fault in absolute position mode

Cause	Confirming Methods	Corrective Action
The motor in absolute position mode does not match or motor SN is set incorrectly.	Check whether motor nameplate is multi-turn absolute encoder motor. Check whether H00-00 (motor SN) is correct.	Set H00-00 correctly or replace matching motor according to motor nameplate.

Er.130: Different DIs allocated with the same function

Cause	Confirming Methods	Corrective Action
1. The same function is allocated to different DIs.	Check whether parameters in groups H03 (H03-02 to H03-20) and H17 (H17-00 to H17-30) are set for the same non-zero DI function.	Re-allocate the parameters that have been allocated with the same non-zero DI function with different DI functions. Then re-connect control power to make modification take effect. Or set the S-ON signal to OFF and give the reset signal to make modification take effect.

Cause	Confirming Methods	Corrective Action
2. The DI function No. exceeds the number of DI functions.	Check whether MCU program is updated.	Restore default setting (H02-31 = 1), and power on the servo drive again.

Er.131: Number of DO functions exceeding the limit

Cause	Confirming Methods	Corrective Action
1. The DO function No. exceeds the number of DO functions.	Check whether MCU program is updated.	Restore default setting (H02-31 = 1), and power on the servo drive again.

Er.136: Data check error or no parameter stored in the motor ROM

Cause	Confirming Methods	Corrective Action
1. Servo drive model and servo motor model do not match.	View servo drive and servo motor nameplates to check that the equipment you are using is IS620P series servo drive and 20-bit servo motor (-U2***) of Inovance.	Replace matched servo drive and servo motor and power on the system again. If you use IS620P series servo drive and 20-bit servo motor (-U2***) of Inovance, ensure that H00-00 = 14000.
2. A parameter check error occurs or no parameter is stored in the serial encoder ROM memory.	Check whether encoder cable you use is standard configuration of Inovance. For cable specification, refer to Chapter 3 in the IS620P User Manual. The cable must not scratch, break or be in poor contact. The cable must be connected reliably. Measure signals PS+, PS-, +5V and GND at both ends of encoder cable and observe whether signals at both ends are consistent. For definition of signals, refer to Chapter 3 in the IS620P User Manual.	Ensure that encoder cable you use is configured by Inovance as standard. Ensure that the cable is connected to the motor securely and tighten the screw on the drive side. If necessary, use a new encoder cable. Never bundle encoder cable and power cables (RST, UVW) together.
3. Servo drive faulty.	The fault persists after servo drive is powered on again.	Replace the servo drive.

Er.201: Overcurrent 2

Cause	Confirming Methods	Corrective Action
1. References are input simultaneously at servo startup or reference input is too quick.	Check whether an reference is input before the keypad displays "rdy".	The time sequence is: after the keypad displays "rdy", set the S-ON signal (S-ON) to ON and then input reference. If allowed, add reference filter time constant or increase acceleration/deceleration time.

Cause	Confirming Methods	Corrective Action
2. The regenerative resistor is too small or short circuited.	<p>If internal regenerative resistor is used (H02-25 = 0), check whether P_b and D are connected with a cable reliably. If yes, measure resistance between C and D.</p> <p>If external regenerative resistor is used (H02-25 = 1/2), measure resistance between P_b and C.</p> <p>For regenerative resistor specification, refer to Chapter 1.</p>	<p>If internal regenerative resistor is used and the resistance is 0, use external regenerative resistor (H02-25 = 1/2) and remove cable between P_b and D. select external regenerative resistor of the same resistance and power as internal regenerative resistor.</p> <p>If external regenerative resistor is used and the resistance is smaller than H02-21 (allowed minimum value of regenerative resistor), connect a new regenerative resistor between P_b and C.</p> <p>Make H02-26 (power of external regenerative resistor) and H02-27 (resistance of external regenerative resistor) consistent with external regenerative resistor specification.</p>
3. Motor cables are in poor contact.	Check whether power cables of servo drive and motor UVW cables are loose.	Fasten the cables that become loose or are disconnected.
4. Motor cables are grounded.	After ensuring power cables of servo drive and motor cables are connected securely, measure insulation resistance between UVW of servo drive and ground cable (PE) and check whether insulation resistance is MQ-level.	Replace motor if insulation is poor.
5. Motor UVW cables are short circuited.	Disconnect motor cables and check whether motor cables (U, V, W) are short circuited and whether burrs exist.	Connect motor cables correctly.
6. Motor is damaged.	Disconnect motor cables and measure whether resistance between motor cables UVW is balanced.	Replace motor if resistance is unbalanced.
7. The gain setting is improper and motor oscillates	Check whether motor oscillates or generates a shrill noise during motor startup and running. You can view current feedback by using the drive Inovance servo commissioning software.	Adjust the gain.
8. Encoder cable is incorrectly wired, corrosive, or connected loosely.	<p>Check whether encoder cable you use is standard configuration of Inovance. check whether cable is aging, corrosive or is connected loosely.</p> <p>Set the S-ON signal to OFF and rotate motor shaft manually. Check whether H0B-10 (electric angle) changes as motor rotates.</p>	Re-weld, fasten or replace encoder cable.
9. Servo drive faulty.	The fault persists after motor cables are disconnected and servo drive is powered on again.	Replace the servo drive.

Er.207: Shaft D/Q current overflow

Cause	Confirming Methods	Corrective Action
1. Shaft D/Q current overflows.	If the fault persists after you power on servo drive several times and restore default setting, it indicates that the servo drive is faulty.	Replace the servo drive.

Er.208: FPGA system sampling operation timeout

Cause	Confirming Methods	Corrective Action
1. MCU communication times out.	Internal fault code H0B-45 = 1208. Internal chip is damaged.	Replace the servo drive.
2. Communication with encoder times out.	Internal fault code H0B-45 = 2208. Encoder wiring is incorrect. Encoder cable becomes loose. Encoder cable is too long. Communication with encoder is interrupted. The encoder is faulty.	Use encoder cable that is configured as standard by Inovance. If not, check whether encoder cable comply with specification and whether it is shielded twisted pair cable. Check whether plugs at both ends of encoder are in good contact and whether any pin retracts. Contact the manufacturer. Do not bundle motor cables and encoder cables together. Ensure servo motor and servo drive are well grounded. Replace servo motor.
3. Current sampling times out.	Internal fault code H0B-45 = 3208. Check whether there is large equipment generating interference on site and whether there are multiple interference sources in the cabinet. Internal current sampling chip is damaged.	Separate heavy current from light current and do not bundle them together. Replace the servo drive.
4. High-accuracy AD conversion times out.	Internal fault code H0B-45 = 4208. Interference exists in high-accuracy AI channel. Check AI wiring according to correct wiring diagram.	Use shielded twisted pair cable and shorten cable length.
5. FPGA operation times out.	Internal fault code H0B-45 = 0208. Remove the cause according to preceding 1/2/3/4.	Perform corrective action according to preceding 1/2/3/4.

Er.210: Output short-circuit to ground

Cause	Confirming Methods	Corrective Action
1. Power output cables (UVW) of servo drive are short-circuited to ground.	Disconnect UVW cables from motor, and measure whether motor UVW cables are short-circuited to ground.	Re-connect these cables or replace them.
2. Motor is short-circuited to ground.	After ensuring power cables of servo drive and motor cables are connected securely, measure insulation resistance between UVW of servo drive and ground cable (PE) and check whether insulation resistance is MΩ-level.	Replace servo motor.
3. Servo drive faulty.	Remove power cables from servo drive. The fault persists after the drive is powered on several times.	Replace the servo drive.

Er.220: Phase sequence incorrect

Cause	Confirming Methods	Corrective Action
1. The UVW phase sequence of the drive is inconsistent with that of the motor.	Carry out power-off and power-on for several times, and Er.220 persists after auto-tuning.	Perform the wiring again and then angle auto-tuning.

Er.234: Runaway

Cause	Confirming Methods	Corrective Action
1. UVW phase sequence is incorrect.	Check whether UVW phase sequence on servo drive is consistent with that on motor side.	Connect UVW cables according to correct phase sequence.
Motor rotor initial phase detection is incorrect due to interference at power-on.	UVW phase sequence is correct. But Er.234 occurs once servo drive is enabled.	Re-power on the servo system.
3. Encoder type is set incorrectly or wiring is incorrect.	View servo drive and servo motor nameplates to check that the equipment you are using is IS620P series servo drive and 20-bit servo motor (-U2***) of Inovance.	Replace matching servo drive and servo motor. If you use IS620P series servo drive and 20-bit servo motor (-U2***) of Inovance, ensure that H00-00 = 14000. Re-confirm motor model, encoder type and encoder wiring.
4. Encoder cable is incorrectly wired, corrosive, or connected loosely.	Check whether encoder cable you use is standard configuration of Inovance. check whether cable is aging, corrosive or is connected loosely. Set the S-ON signal to OFF and rotate motor shaft manually. Check whether H0B-10 (electric angle) changes as motor rotates.	Re-weld, fasten or replace encoder cable.
5. When controlling a vertical shaft, gravity load is too large.	Check whether load of vertical shaft is too large. Adjust brake parameters H02-09 to H02-12 and then see whether the fault is removed.	Reduce load of vertical shaft, improve rigidity or shield this fault on the prerequisite of not affecting safety and use.

**CAUTION**

On working condition of controlling a vertical shaft or one motor dragging the other, set H0A-12 = 0 to shield the runaway fault.

Er.400: Main circuit overvoltage

Cause	Confirming Methods	Corrective Action
5 1. Main circuit input voltage is too high	Check power input specification of servo drive. Measure RST input voltage on servo drive side and check whether input voltage complies with the following specification. 220 V AC drive: Valid value: 220 to 240 V Allowed error: -10% to 10% (198 to 264 V) 380V AC drive: Valid value: 380 to 480 V Allowed error: -10% to 10% (342 to 528 V)	Replace power supply or adjust power voltage according to specification on the left.
2. Power supply is instable or affected by the lightning strike.	Check whether power supply is instable, affected by lightning strike or satisfies preceding specification.	Connect a surge suppressor and then connect power supply. If the fault persists, replace the servo drive.

Cause	Confirming Methods	Corrective Action
3. The regenerative resistor fails.	<p>If internal regenerative resistor is used (H02-25 = 0), check whether P_B and D are connected with a cable reliably. If yes, measure resistance between C and D.</p> <p>If external regenerative resistor is used (H02-25 = 1/2), measure resistance between P_B and C.</p> <p>For regenerative resistor specification, refer to Chapter 1.</p>	<p>If resistance is ∞, wire breaking occurs.</p> <p>If internal regenerative resistor is used and resistance is 0, use external regenerative resistor (H02-25 = 1/2) and remove cable between P_B and D. Select external regenerative resistor of the same resistance and power as internal regenerative resistor.</p> <p>If external regenerative resistor is used, connect a new regenerative resistor between P_B and C.</p> <p>Make H02-26 (power of external regenerative resistor) and H02-27 (resistance of external regenerative resistor) consistent with external regenerative resistor specification.</p>
Resistance of the regenerative resistor is too large, and energy absorption during braking is insufficient.	<p>Measure resistance of the external regenerative resistor between P_B and C. Compare the measured value with the recommended value.</p>	<p>Connect a new external regenerative resistor of recommended resistance between P_B and C.</p> <p>Make H02-26 (power of external regenerative resistor) and H02-27 (resistance of external regenerative resistor) consistent with external regenerative resistor specification.</p>
Motor is in abrupt acceleration/ deceleration status. Maximum braking energy exceeds energy absorption value.	<p>Confirm acceleration/deceleration time during running and measure DC bus voltage between P_B and ⊖. Check whether voltage exceeds fault level during deceleration.</p>	<p>First, ensure that input voltage of main circuit is within specification. Then increase acceleration/ deceleration time in allowed range.</p>
Bus voltage sampling value has a large deviation from the measured value	<p>Check whether H0B-26 (bus voltage) is within the following specification: 220 V drive: H0B-26 > 420 V 380 V drive: H0B-26 > 760V</p> <p>Measure the DC bus voltage between P_B and ⊖. Check whether the DC bus voltage is normal and smaller than H0B-26.</p>	<p>Contact Inovance for technical support.</p>
7. The servo drive is faulty.	<p>The fault persists after main circuit is powered on several times.</p>	<p>Replace the servo drive.</p>

Er.410: Main circuit undervoltage

Cause	Confirming Methods	Corrective Action
1. The main power is unstable or fails.	Check power input specification of servo drive. Measure RST input voltage on servo drive side and check whether input voltage complies with the following specification. 220 V AC drive: Valid value: 220 to 240 V	Increase power capacity. For details, refer to Chapter 1 in the IS620P User Manual.
2. Instantaneous power down occurs.	Allowed error: -10% to 10% (198 to 264 V) 380V AC drive: Valid value: 380 to 480 V Allowed error: -10% to 10% (342 to 528 V) All the three phases must be measured.	
3. Voltage dip occurs during running.	Check power input voltage and check whether main power is applied to other devices, resulting insufficient power capacity and voltage dip.	
4. Phase loss exists: Single-phase power is applied to three-phase servo drive.	Check whether main circuit RST wiring is correct and reliable, and whether phase loss fault detection (H0A-00) is shielded.	Replace cables and connect main circuit correctly. Three phases: R, S, T Single-phase: L1, L2
5. The servo drive is faulty.	Check whether H0B-26 (bus voltage) is within the following specification: 220V drive: H0B-26 < 200 V 380 V drive: H0B-26 < 380 V The fault persists after main circuit is powered on several times.	Replace the servo drive.

Er.420: Power cable phase loss

Cause	Confirming Methods	Corrective Action
The RST cables are not connected well.	Check whether RST cables on servo drive side and non-servo drive side are in good condition and connected securely.	Replace cables and connect main circuit correctly.
2. Single-phase power is applied to three-phase servo drive.	Confirm power input specification and actual input voltage. Check whether input voltage of each phase of main circuit satisfies the following specification: 220 V AC drive: Valid value: 220 to 240 V Allowed error: -10% to 10% (198 to 264 V)	For servo drive of 0.75 kW (H01-02 = 5), it can be applied by single-phase power supply. If input voltage satisfies specification on the left, set H0A-00 = 2 (forbid faults and warnings). If input voltage does not satisfy specification on the left, replace or adjust power capacity.
3. Three-phase voltage is unbalanced or voltages of all three phases are too low.	380V AC drive: Valid value: 380 to 480 V Allowed error: -10% to 10% (342 to 528 V) All the three phases must be measured..	
4. The servo drive is faulty.	The fault persists after main circuit (R, S, T) is powered on several times.	Replace the servo drive.

Er.430: Control power undervoltage

Cause	Confirming Methods	Corrective Action
1. The control power is unstable or fails.	Check whether it is in the process of cutting off the control power (L1C, L2C) or instantaneous power failure occurs.	Re-power on the servo drive. If the fault is abnormal power failure, keep power supply stable.
	Check whether input voltage of control cables satisfies the following specification: 220 V AC drive: Valid value: 220 to 240 V Allowed error: -10% to 10% (198 to 264 V) 380V AC drive: Valid value: 380 to 480 V Allowed error: -10% to 10% (342 to 528 V)	Increase power capacity.
2. The control power cables are in poor contact.	Check whether control cables are well connected and whether voltage of control cables (L1C, L2C) satisfies preceding specification.	Re-connect or replace control power cables.

Er.500: Overspeed

Cause:

Actual speed of servo motor exceeds overspeed level.

Cause	Confirming Methods	Corrective Action
1. UVW phase sequence is incorrect.	Check whether UVW phase sequence on servo drive is consistent with that on motor side.	Connect UVW cables according to correct phase sequence.
2. The setting of H0A-08 is incorrect.	Check whether overspeed level is smaller actual maximum motor speed. Overspeed level = 1.2 times of maximum motor speed (H0A-08 = 0) Overspeed level = H0A-08 (H0A-08 ≠ 0, and H0A-08 < 1.2 times of maximum motor speed)	Reset overspeed level according to actual mechanical requirement.
3 Input reference is higher than overspeed level.	Check whether motor speed corresponding to input reference exceeds overspeed level. When the reference source is pulse in the position control mode: Motor speed (RPM) = $\frac{\text{Input pulse frequency (Hz)}}{\text{Encoder resolution}} \times \text{Electronic gear ratio} \times 60$ For IS620P servo drive, the encoder resolution is 1048576P/r. For IS600P servo drive, the encoder resolution is 10000 P/r.	In position control: When reference source is pulse, reduce pulse frequency in the prerequisite of ensuring accurate positioning or decrease the electronic gear ration if motor speed allows. In speed control: View speed reference and speed limit (H06-06 to H06-09) and confirm that they are within the overpspeed level. In torque control: Set speed limit within the overspeed level. For speed limit in torque control, refer to the IS620P User Manual.
4. Motor speed overshoots.	Check whether speed feedback exceeds overspeed level through the drive debugging platform of Inovance.	Adjust the gain or adjust mechanical condition.
5. The servo drive is faulty.	The fault persists after servo drive is re-powered on.	Replace the servo drive.

Er.510: Pulse output overspeed

Cause	Confirming Methods	Corrective Action
Output pulse frequency exceeds frequency upper limit allowed by hardware (2 MHz).	When H05-38 = 0 (encoder frequency-division output), calculate pulse frequency corresponding to motor speed at occurrence of fault and check whether the pulse frequency exceeds limit. Output pulse frequency (Hz) = $\frac{\text{Motor speed (rpm)}}{60} \times \text{H05-17}$	Decrease H05-17 (Encoder frequency-division pulses), making output pulse frequency below frequency upper limit allowed by hardware in the speed range required by mechanical condition.
Output pulse frequency exceeds frequency upper limit allowed by hardware (2 MHz).	When H05-38 = 1 (reference pulse synchronous output), input pulse frequency exceeds 2 MHz or interference exists on pulse input pin. Low-speed pulse input pin: Differential input terminals, PULSE+, PULSE-, SIGN+, SIGN- Max. pulse frequency: 500 kpps Open-collector input terminals, PULLHI, PULSE+, PULSE-, SIGN+, SIGN- Max. pulse frequency: 200 kbps High-speed pulse input pin: Differential input terminals: HPULSE+, HPULSE-, HSIGN+, HSIGN- Max. pulse frequency: 2 Mpps	Decrease input pulse frequency to within frequency upper limit allowed by hardware. In this case, if you do not modify electronic gear ratio, motor speed will slow down. If input pulse frequency is very high but is still within frequency upper limit allowed by hardware, take anti-interference measures (use STP cable for pulse input and set pin filter parameters H0A-24 or H0A-30), which prevents interference pulse adding to pulse and resulting in fault misreported.

Er.602: Angle auto-tuning failure

Er.610: Servo drive overload

Cause	Confirming Methods	Corrective Action
1. Parameter setting is incorrect.	Check whether H01-02 (drive SN) is set correctly. Check whether the gain parameters (group H08) or the stiffness (H09-00 and H09-01) are set correctly.	Set H01-02 according to the actual drive SN. Adjust the parameters based on the current feedback effect.
The servo drive load ratio is too large (load inertia excessive).	Check whether H0B-12 (average load ratio) is excessive (over 80%) and then whether the inertia is excessive through inertia auto-tuning.	Use a drive model of higher power.
3. The servo drive load ratio is too large (mechanical stuck)	Check whether H0B-12 (average load ratio) is excessive (over 80%) and then whether stuck occurs during load running.	Eliminate the mechanical stuck problem.
4. Locked rotor occurs in the motor.	Check whether H0A-33 (locked rotor over-temperature protection) is 0. If yes, the drive trips Er.610 when locked rotor occurs.	Take actions for Er.630.

Er.620: Motor overload

Cause	Confirming Methods	Corrective Action
1. Wiring of motor and encoder is incorrect or poor.	Check wirings between servo drive, servo motor and encoder according to correct wiring diagram.	Connect wirings based on correct wiring diagram. Prefer to use the cable configured by Inovance as standard. When self-made cable is used, make and connect wirings according to hardware wiring guidance.
2. The load is too heavy. The motor keeps output of effective torque higher than rated torque for a long time.	Confirm overload characteristic of servo drive or servo motor. Check whether average load rate (H0B-12) is greater than 100.0% for long time.	Replace a large servo drive and matching servo motor. Reduce the load and increase acceleration/deceleration time.
3. Acceleration/ deceleration is too frequent or the load inertia is too large.	Calculate the load inertia ratio or perform the load inertia ratio auto-tuning. Then view H08-15 (load inertia ratio). Conform single running cycle when servo motor runs in circular.	Increase acceleration/deceleration time during single running.
4. The gain is improper, causing too high rigidity.	Observe whether motor vibrates and generates noise during running.	Adjust the gain.
5. The servo drive or motor model is set incorrectly.	For IS620P series products, view serial encoder motor model in H00-05 and servo drive model in H01-02.	View servo drive nameplate and set servo drive model (H01-02) correctly and replace matching servo motor according to the IS620P User Manual.
6. Locked-rotor occurs due to mechanical factors, resulting in very heavy load during running.	Check running reference and motor speed (H0B-00) by using the drive Inovance servo commissioning software or keypad. Running reference in position control: H0B-13 (input reference pulse counter) Running reference in speed control: H0B-01 (speed reference) Running reference in torque control: H0B-02 (internal torque reference) Check running reference in corresponding mode is not 0 but the motor speed is 0.	Eliminate mechanical factors.
7. The servo drive is faulty.	The fault persists after servo drive is powered on again.	Replace the servo drive.

**CAUTION**

You can clear the fault or re-power on the system 30s after overload occurs.

Er.625: Brake applied abnormally

Cause	Confirming Methods	Corrective Action
1. The motor brake is not released.	Check whether the motor brake signal is active and whether the brake switch is damaged.	Perform the wiring again or replace the motor.

Er.626: Brake released abnormally

Cause	Confirming Methods	Corrective Action
1. The motor brake is released.	Check whether the motor brake signal is active and whether the brake switch is damaged.	Perform the wiring again or replace the motor.

Er.630: Overheat protection of locked-rotor motor

Cause	Confirming Methods	Corrective Action
1. Power output phase (UVW) loss or incorrect phase sequence occurs on servo drive.	Perform motor trial running when there is no load and check motor wirings.	Connect motor cables correctly again or replace them.
2. UVW cable or encoder cable breaks.	Check wirings.	Connect wirings correctly again or replace them.
3. Motor rotor is locked due to mechanical factors.	<p>Check running reference and motor speed (H0B-00) by using the drive debugging platform of Inovance or operating panel.</p> <p>Running reference in the position control mode: H0B-13 (input reference pulse counter)</p> <p>Running reference in speed control: H0B-01 (speed reference)</p> <p>Running reference in torque control: H0B-02 (internal torque reference)</p> <p>Check running reference in corresponding mode is not 0 but the motor speed is 0.</p>	Eliminate mechanical factors.

Er.650: Heatsink overheat

Cause	Confirming Methods	Corrective Action
1. Ambient temperature is too high.	Measure ambient temperature.	Improve cooling conditions to reduce ambient temperature.
2. Servo drive is powered off to reset overload fault.	View the fault records (set H0B-33 and view H0B-34) and check whether overload fault (Er.610, Er.620, Er.630, Er.650, Er.909, Er.920, Er.922) occurs.	Change fault reset method. After overload occurs, wait 30s and then perform reset operation. Increase capacity of servo drive and servo motor, increase acceleration/deceleration time, and reduce load.
3. The fan is damaged.	Observe whether the fan rotates during running.	Replace the servo drive.
4. Installation direction and clearance of the servo drive are improper.	Check whether installation of servo drive is proper.	Install servo drive according to mounting requirements.
5. The servo drive is faulty.	The fault persists after restart 5 minutes after power-off.	Replace the servo drive.

Er.731: Encoder battery failure

Cause	Confirming Methods	Corrective Action
The battery is not connected during power-off.	Check whether battery is connected during power-off.	Set H0D-20 = 1 to remove the fault.
The encoder battery voltage is too low.	Measure the battery voltage.	Replace a new battery with matching voltage.

Er.733: Encoder multi-turn counting error

Cause	Confirming Methods	Corrective Action
The encoder is faulty.	Set H0D-20 = 1 to remove the fault. Er.733 persists after power-on again.	Replace servo motor.

Er.735: Encoder multi-turn counting overflow

Cause	Confirming Methods	Corrective Action
Encoder multi-turn counting overflow is detected when H02-01 = 1.	-	Set H0D-20 = 1 and power on the system again.

Er.740: Encoder interference

Cause	Confirming Methods	Corrective Action
1. Encoder wiring is incorrect.	Check encoder wiring.	Re-connect the encoder according to correct wiring diagram.
2. Encoder cable becomes loose.	Check whether on-site vibration is too large, which loosens encoder cable and even damages the encoder.	Re-connect encoder cable securely.
3. The encoder Z signal suffers interference	<p>Check on-site wirings:</p> <p>Check whether there is large equipment generating interference around servo system or whether there are several variable-frequency power devices inside the cabinet.</p> <p>Make servo drive in "rdy" status and rotate motor shaft counterclockwise (CCW) manually and observe whether H0B-10 (rotation angle/electrical angle) increases/decreases smoothly. Turning one circle corresponds to five 0-360° (for Z series motor). For X series motor, turning one circle corresponds to four 0-360°.</p> <p>If H0B-10 changes abnormally during rotation, it indicates that a fault occurs on encoder.</p> <p>If there is no alarm during rotation but the system alarms during servo running, it is extremely possible that interference exists.</p>	<p>Prefer to use the cable configured by Inovance as standard.</p> <p>If non-standard cable is used, check whether the cable meets requirements and is STP cable.</p> <p>Do not bundle motor cables and encoder cables together. Ensure servo motor and servo drive are well grounded.</p> <p>Check whether plugs at both ends of encoder are in good contact and whether any pin retracts.</p>
4. The encoder is faulty.	<p>Replace a new encoder cable. If the fault no longer occurs after replacement, it indicates that the original encoder is damaged</p> <p>Place motor at the same position, power on the system several times and observe change of H0B-10. The electrical angle must be within $\pm 30^\circ$</p>	<p>Replace a new encoder cable.</p> <p>If not, it indicates that the encoder is damaged. You need to replace servo motor.</p>

Er.834: AD sampling overvoltage

Cause	Confirming Methods	Corrective Action
1. AI voltage is too high.	Measure voltage input from AI and check whether AI sampling voltage (H0B-21 or H0B-22) is greater than 11.5 V.	Adjust AI input voltage and view AI sampling voltage until AI sampling voltage does not exceed 11.5 V.

Cause	Confirming Methods	Corrective Action
2. AI wiring is incorrect or interference exists.	Check AI wiring according to correct wiring diagram.	Use shielded twisted pair cable and shorten cable length. Increase AI filter time constant: AI1 filter time constant: H03-51 AI2 filter time constant: H03-56

Er.835: High-accuracy AD sampling fault

Cause	Confirming Methods	Corrective Action
1. Interference exists on high-accuracy AI.	Check AI wiring according to correct wiring diagram.	Use shielded twisted pair cable and shorten cable length.

Er.A33: Encoder data abnormal

Cause	Confirming Methods	Corrective Action
1. The serial encoder cable breaks or becomes loose.	Check wirings.	Check connection of encoder cable to see whether incorrect connection, wire breaking, or poor contact exists. If motor cables and encoder cable are bundled together, separate them.
2. Serial encoder parameters read-write is abnormal.	If the fault persists after you power on servo drive several times, it indicates that the encoder is faulty.	Replace servo motor.

Er.A34: Encoder communication check abnormal

Cause	Confirming Methods	Corrective Action
1. Servo drive model and servo motor model do not match.	View servo drive and servo motor nameplates to check that the equipment you are using is IS620P series servo drive and 20-bit servo motor (-U2****) of Inovance. Meanwhile, check whether H00-00 (Motor SN) is 14000.	Replace matching servo drive and servo motor.
2. Encoder cable breaks.	Check whether encoder cable breaks and whether connection of servo drive and connection of servo motor are secure.	Replace a new encoder cable and secure wirings.

Er.A35: Z signal lost

Cause	Confirming Methods	Corrective Action
1. Z signal gets lost because of encoder fault.	Use a new encoder cable and connect wirings correctly. Then rotate motor shaft manually and check whether the fault persists.	Replace servo motor.
Poor contact or incorrect connection results in Z signal lost.	Rotate motor shaft manually and check whether the fault persists.	Check whether encoder cable is in good contact. Re-connect wirings or replace encoder cable.

Er.B00: Position deviation being large

Cause	Confirming Methods	Corrective Action
1. Power output phase (UVW) loss or incorrect phase sequence occurs on servo drive.	Perform motor trial running when there is no load and check motor wirings.	Connect wirings correctly again or replace them.

Cause	Confirming Methods	Corrective Action
2. UVW cable or encoder cable breaks.	Check wirings.	Reconnect the UVW cable. Power cables of servo motor and power cables UVW of servo drive must be one-to-one correspondence. If necessary, replace a new cable and ensure reliable connection.
3. Motor rotor is locked due to mechanical factors.	Check running reference and motor speed (H0B-00) by using the drive debugging platform of Inovance or operating panel. Running reference in the position control mode: H0B-13 (input reference pulse counter) Running reference in speed control: H0B-01 (speed reference) Running reference in torque control: H0B-02 (internal torque reference) Check running reference in corresponding mode is not 0 but the motor speed is 0.	Eliminate mechanical factors.
4. Servo drive gain is low.	Check servo drive position loop gain and speed loop gain. 1st gain: H08-00 to H08-02 2nd gain: H08-03 to H08-05	Adjust gain manually or perform automatic gain auto-tuning according to Chapter 6 in the IS620P User Manual.
5. Input pulse frequency is high.	Check whether input pulse frequency is too high if position reference source is pulse. Acceleration/deceleration time is 0 or too small.	Reduce position reference frequency or decrease electronic gear ratio. When host computer is used to output position pulses, set acceleration/deceleration time in host computer. If host computer is not allowed to set acceleration/deceleration time, increase parameters H05-04 and H05-06 to smoothen position reference.
6. Relative to running condition, H0A-10 (threshold of position deviation fault) is too small.	Check whether the setting of H0A-10 is too small.	Increase the setting of H0A-10.
7. The servo drive/motor is faulty.	Monitor running curve on the drive debugging platform of Inovance: Position reference, position feedback, speed reference, torque reference	If position reference is not 0, but position feedback is always 0, replace servo drive/motor.

Er.B01: Pulse input abnormal

Cause	Confirming Methods	Corrective Action
1. Input pulse frequency is greater than H0A-09 (Maximum position pulse frequency).	Check whether H0A-09 is smaller than maximum input pulse frequency required by normal machine running.	Reset H0A-09 correctly according to the actual requirement. If output pulse frequency of host computer is larger than 4 MHz, decrease it.

Cause	Confirming Methods	Corrective Action
2. Input pulse suffers interference.	<p>Check whether position reference increases abruptly or whether H0B-13 (input reference pulse counter) is larger than the number of pulses output by host computer through oscilloscope.</p> <p>Then check grounding situation of connecting cables.</p>	<p>First, use an STP cable for pulse input and separate pulse input cable from servo drive power cables.</p> <p>Then, when differential input is selected on the condition of using low-speed pulse input terminal (H05-01 = 0), ground of host computer must be connected to GND of servo drive reliably. If open-collector input is selected, ground of host computer must be connected to COM of servo drive reliably. Only differential input can be selected on the condition of using high-speed pulse input terminal (H05-01 = 1), ground of host computer must be connected to GND of servo drive reliably.</p> <p>Finally, according to selected hardware input terminal, increase pin filter time of pulse input terminal in H0A-24 or H0A-30.</p>

Er.B02: Position deviation being too large in full closed-loop

Cause	Confirming Methods	Corrective Action
1. Power output phase (UVW) loss or incorrect phase sequence occurs on servo drive.	Perform motor trial running when there is no load and check motor wirings.	Connect wirings correctly again or replace them.
2. U/V/W cable or internal/external encoder cable breaks.	Check wirings.	Reconnect the U/V/W cable. Power cables of servo motor and power cables U/V/W of servo drive must be one-to-one correspondence. If necessary, replace a new cable and ensure reliable connection.
3. Motor rotor is locked due to mechanical factors.	<p>Check running reference and motor speed (H0B-00) by using the drive debugging platform of Inovance or operating panel.</p> <p>Running reference in the position control mode: H0B-13 (input reference pulse counter)</p> <p>Running reference in speed control: H0B-01 (speed reference)</p> <p>Running reference in torque control: H0B-02 (internal torque reference)</p> <p>Check running reference in corresponding mode is not 0 but the motor speed is 0.</p>	Eliminate mechanical factors.
4. Servo drive gain is low.	<p>Check servo drive position loop gain and speed loop gain.</p> <p>First gain: H08-00 to H08-02</p> <p>Second gain: H08-03 to H08-05</p>	Adjust gain manually or perform automatic gain auto-tuning according to Chapter 6 in the IS620P User Manual.
5. Input pulse frequency is high.	<p>Check whether input pulse frequency is too high if position reference source is pulse.</p> <p>Acceleration/deceleration time is 0 or too small.</p>	<p>Reduce position reference frequency or decrease electronic gear ratio.</p> <p>When host computer is used to output position pulses, set acceleration/deceleration time in host computer.</p> <p>If host computer is not allowed to set acceleration/deceleration time, increase parameters H05-04 and H05-06 to smoothen position reference.</p>

Cause	Confirming Methods	Corrective Action
6. Relative to running condition, H0F-08 (full closed-loop position deviation too large threshold) is too small.	Check whether full closed-loop position deviation too large threshold (H0F-08) is too small.	Increase the setting of H0F-08.
7. The servo drive/motor is faulty.	Monitor running curve on the drive debugging platform of Inovance: Position reference, position feedback, speed reference, torque reference	If position reference is not 0, but position feedback is always 0, replace servo drive/motor.

Er.B03: Electronic gear ratio setting exceeding limit

Cause	Confirming Methods	Corrective Action
Electronic gear ratio setting exceeds preceding limit.	If H05-02 = 0, check the ratios of H05-07/H05-09 and H05-11/H05-13 If H05-02 > 0, check the ratios of encoder resolution/H05-02, H05-07/H05-09 and H05-11/H05-13.	The ratios of encoder resolution /H05-02, H05-07/H05-09, and H05-11/H05-13 must be within preceding limit.
Parameter modification sequence is unreasonable.	When modifying electronic gear ration related parameters H05-02, H05-07/H05-09, and H05-11/H05-13, modifying sequence is unreasonable, which results in electronic gear ratio exceeding limit during calculation of electronic gear ratio.	Reset the fault or re-power on the system.

Er.B04: Fully closed-loop function parameter setting error

Cause	Confirming Methods	Corrective Action
In full closed-loop mode, position reference source is internal position reference but internal encoder feedback and external encoder feedback is switched over.	Check whether H0F-00 = 2. Check whether position reference source is internal position reference: multi-position and position change on fly.	In full closed-loop mode, when position reference source is internal position reference, only external encoder feedback can be used. That is, H0F-00 can be set to 1 only.

Er.D03: CAN communication interrupted

Cause	Confirming Methods	Corrective Action
CAN communication is interrupted. The slave station is offline.	Check the CAN communication card indicator status of the master PLC. The ERR indicator of master PLC flashes at frequency 1 Hz and the ERR indicator of some slave PLCs keeps ON for a long period. (When using PLC commissioning software, you can monitor D78xx in component monitoring table of the master. xx indicates station No. in decimal. If corresponding D78xx of some configured stations is 5, it indicates that a fault occurs on the slave PLC).	Check communication cable connection between the slave with ERR indicator ON for long time and master. Check communication baud rate (H0C-08) of the slave with ERR indicator ON for long time and adjust baud rate the same as that of the master.
CAN communication is interrupted. The master station is offline.	Check the CAN communication card indicator status of the master PLC. The ERR indicator of all slave PLCs keeps ON for a long period. (When using PLC commissioning software, you can monitor D78xx in the component monitoring table of the master. xx indicates station No. in decimal. If corresponding D78xx of all configured stations is 5, it indicates that a fault occurs on the master PLC.)	Check wirings of the master PLC.

5.2.3 Troubleshooting of Warnings

Er.110: Setting error of frequency-division pulse output

Cause	Confirming Methods	Corrective Action
The number of frequency-division pulses of encoder does not conform to the specification.	For incremental encoder, the number of frequency-division pulses cannot exceed encoder resolution. Resolution of 20-bit serial incremental encoder is 1048576 P/r. Resolution of 2500-PPR serial incremental encoder is 10000 P/r. For absolute encoder, the number of frequency-division pulses cannot exceed one fourth of encoder resolution.	Reset H05-17 (Encoder frequency-division pulses) correctly according to the specification.

Er.601: Homing timeout

Cause	Confirming Methods	Corrective Action
1. The home switch fails.	There is only high-speed searching and no low-speed searching during operation of returning to home. After high-speed searching of returning to home, the drive keeps reverse low-speed searching.	If hardware DI is used, check whether DI function FunIN.31: HomeSwitch (home switch) has been allocated to a DI and then check wiring of the DI. Make logic of the DI change manually and observe whether servo drive receives level change of the DI through H0B-03. If not, wiring of the DI is incorrect. If yes, a fault occurs during operation of returning to home. Please use the returning to home function correctly. If a virtual DI is used, check whether VDI is used correctly according to the IS620P User Manual.
2. The search time is too short.	Check whether time for homing set in H05-35 is too short.	Increase H05-35.
3. Speed of high-speed searching home switch signal is too small.	Check distance from initial position of returning to home to home switch. Then check whether H5-32 (speed of home switch signal at high-speed searching) is too small, resulting in too long time of finding home switch.	Increase H05-32.

Er.730: Encoder battery warning

Cause	Confirming Methods	Corrective Action
Battery voltage of absolute encoder is lower than 3.0 V.	Measure battery voltage.	Replace a new battery with matching voltage.

5

Er.831: AI zero drift too large

Cause	Confirming Methods	Corrective Action
1. AI wiring is incorrect or interference exists.	Check wiring by referring to correct wiring diagram.	Use shielded twisted pair cable and shorten cable length. Increase AI filter time constant: AI1 filter time constant: H03-51 AI2 filter time constant: H03-56
2. The servo drive is faulty.	Disconnect AI cable (input voltage is 0). Check whether AI sampling value in group H0B exceeds 500 mV.	If AI sampling value in group H0B exceeds 500 mV, replace the servo drive.

Er.900: DI emergency braking

Cause	Confirming Methods	Corrective Action
DI function FunIN.34: EmergencyStop is triggered.	Check whether logic of DI set for FunIN.34: EmergencyStop is valid.	Check the running mode and clear DI braking valid signal on the prerequisite of ensuring safety.

Er.909: Motor overload warning

Cause	Confirming Methods	Corrective Action
1. Wiring of motor and encoder is incorrect or poor.	Check wirings between servo drive, servo motor and encoder according to correct wiring diagram.	Connect wirings based on correct wiring diagram. Prefer to use the cable configured by Inovance as standard. When self-made cable is used, make and connect wirings according to hardware wiring guidance.
2. The load is too heavy. The motor keeps output of effective torque higher than rated torque for a long time.	Confirm overload characteristic of servo drive or servo motor. Check whether average load rate (H0B-12) is greater than 100.0% for long time.	Replace a large servo drive and matching servo motor. Reduce the load and increase acceleration/deceleration time.
3. Acceleration/deceleration is too frequent or load inertia is too large.	Calculate load inertia ratio or perform load inertia ratio auto-tuning. Then view H08-15 (load inertia ratio). Conform single running cycle when servo motor runs in circular.	Increase acceleration/deceleration time.
4. The gain is improper, causing too high rigidity.	Observe whether motor vibrates and generates noise during running.	Adjust the gain.
5. The servo drive or motor model is set incorrectly.	For IS620P series products, view serial encoder motor model in H00-05 and servo drive model in H01-02.	View servo drive nameplate and set servo drive model (H01-02) correctly and replace matching servo motor according to the IS620P User Manual.
6. Locked-rotor occurs due to mechanical factors, resulting in very heavy load during running.	Check running reference and motor speed (H0B-00) by using the drive debugging platform of Inovance or operating panel. Running reference in the position control mode: H0B-13 (input reference pulse counter) Running reference in speed control: H0B-01 (speed reference) Running reference in torque control: H0B-02 (internal torque reference) Check running reference in corresponding mode is not 0 but the motor speed is 0.	Eliminate mechanical factors.
7. The servo drive is faulty.	Power off the servo drive and then power it on again.	If the fault persists after re-power-on, replace the servo drive.

Er.920: Regenerative resistor overload

Cause	Confirming Methods	Corrective Action
1. Wiring of external regenerative resistor is in poor connection, becomes loose or breaks.	Disconnect external regenerative resistor and measure whether resistance of the resistor is ∞ . Measure whether resistance between P_b and C is ∞ .	Replace a new external regenerative resistor and measure its resistance. If the resistance is consistent with nominal value, connect it between P_b and C.
		Select a new cable and connect it between P_b and C.
2. Jumper across terminals PⓄ and D is shorted or disconnected when the internal regenerative resistor is used.	Measure whether resistance between P_b and D is ∞ .	Select a new cable and connect it between P_b and D.
3. Setting of H02-25 is incorrect when external regenerative resistor is used.	View setting value of H02-25. Measure resistance of external regenerative resistor connected between P_b and C. Check whether the resistance is too large by comparing it with the regenerative resistor specification table in the IS620P User Manual.	Set H02-25 correctly according to the IS620P User Manual. H02-25 = 1 (external regenerative resistor used, naturally ventilated) H02-25 = 2 (external regenerative resistor used, forcible cooling)
	4. Resistance of the used external regenerative resistor is too large.	Select a proper regenerative resistor according to the IS620P User Manual.
5. H02-27 (resistance of external regenerative resistor) is larger than resistance of the used external regenerative resistor.	Check whether setting value of H02-27 is greater than resistance of external regenerative resistor connected between P_b and C.	Set H02-27 (resistance of external regenerative resistor) consistent with the resistance of the selected external regenerative resistor.
6. Input voltage of main circuit exceeds specification.	Check whether input voltage of main circuit on servo drive side satisfies the following specification: 220 V AC drive: Valid value: 220 to 240 V Allowed error: -10% to 10% (198 to 264 V) 380V AC drive: Valid value: 380 to 480 V Allowed error: -10% to 10% (342 to 528 V)	Replace power supply or adjust power voltage according to specification on the left.
7. The load inertia is too large.	Perform inertia auto-tuning according to the IS620P User Manual or calculate total inertia of machine according to mechanical parameters. Check whether actual load inertia ratio exceeds 30.	Select a large external regenerative resistor and set H02-26 (power of external regenerative resistor) consistent with actual value.
	8. Speed is too high, and deceleration is not completed within required time. The regenerative resistor is in continuous deceleration status.	View speed curve of motor for cycle running and check whether motor is in deceleration status for a long period.
9. Capacity of servo drive or regenerative resistor is insufficient.	View single cycle speed curve of motor and calculate whether maximum braking energy can be absorbed completely.	If allowed, increase motor running cycle.

Cause	Confirming Methods	Corrective Action
10. The servo drive is faulty.	-	Replace a new servo drive.

Er.922: Resistance of external braking resistor too small

Cause	Confirming Methods	Corrective Action
When an external regenerative resistor is used (H02-25 = 1 or 2), resistance of the external regenerative resistor is smaller than minimum value required by servo drive.	Measure resistance of the external regenerative resistor between P_b and C and check whether it is smaller than H02-21 (allowed minimum value of regenerative resistor).	If yes, connect an external regenerative resistor matching servo drive between P_b and C and set H02-27 (resistance of external regenerative resistor) to resistance of the selected regenerative resistor. If not, set H02-27 to resistance of the selected regenerative resistor.

Er.939: Motor power cable breaking

Cause	Confirming Methods	Corrective Action
Motor power cable breaking	Check whether difference between H0B-24 (phase current valid value) and H0B-02 (internal torque reference) reaches over 500%. Meanwhile, H0B-00 (actual motor speed) is smaller than one fourth of rated motor speed.	Check the motor power cable connection and reconnect wirings. If necessary, replace a new cable.

Er.941: Parameter modification taking effect only after re-power-on

Cause:

Modification of some parameters takes effect only after servo drive is powered on again. After these parameters are modified, servo drive reminds of re-power-on.

Cause	Confirming Methods	Corrective Action
Modify parameters, whose modification takes effect only after re-power-on.	Check whether you modify parameters, whose modification takes effect only after re-power-on.	Re-power on the servo system.

Er.942: Parameter storage too frequent

Cause	Confirming Methods	Corrective Action
A great number of parameters are modified and stored frequently to EEPROM (H0C-13 = 1).	Check whether host controller performs frequent and fast parameter modification on servo drive.	Check the running mode. For the parameters that need not be stored in EEPROM, set H0C-13 to 0 before writing operation of host controller.

5

Er.950: Forward limit switch warning

Cause	Confirming Methods	Corrective Action
Logic of DI set for FunIN.14: P-OT (forward limit switch) is valid.	Check whether a parameter in group H03 is set for FunIN14 (P-OT). Check whether logic of corresponding DI is valid in H0B-03 (monitored DI states).	Check the running mode. Send a reverse reference or rotate motor on the prerequisite of ensuring safety to make logic of the forward overshoot switch terminal invalid.

Er.952: Reverse limit switch warning

Cause	Confirming Methods	Corrective Action
Logic of DI set for FunIN.15: N-OT (reverse limit switch) is valid.	Check whether a parameter in group H03 is set for FunIN15 (N-OT). Check whether logic of corresponding DI is valid in H0B-03 (monitored DI states).	Check the running mode. Send a reverse reference or rotate motor on the prerequisite of ensuring safety to make logic of the reverse overshoot switch terminal invalid.

Er.980: Encoder internal fault

Cause	Confirming Methods	Corrective Action
It is encoder internal fault.	If the fault persists after you power on servo drive several times, it indicates that the encoder is faulty.	Replace servo motor.

Er.990: Power input phase loss warning

Cause	Confirming Methods	Corrective Action
When H0A-00 = 1 (allow faults and warnings at power input phase loss protection), three-phase servo drive (0.75 kW) (H01-02 = 5) can run under single-phase power. When single-phase power is connected, this warning is reported.	Check whether it is a three-phase servo drive allowed to run under single-phase power.	If the warning persists when a three-phase servo drive is connected to three-phase power, troubleshoot it as Er.420 (power cable phase loss). If the warning persists when a three-phase servo drive is connected to single-phase power, set H0A-00 to 0.

Er.994: CAN address conflict

Cause	Confirming Methods	Corrective Action
CAN address conflict occurs.	Check whether H0C-00 (servo shaft address) is allocated repeatedly.	Allocate servo shaft address of slaves and ensure that allocation of H0C-00 is not repeated.

5.2.4 Internal Faults

When any of the following fault occurs, contact Inovance for technical support.

Er.602: Angle auto-tuning failure

Er.220: Phase sequence incorrect

Er.A40: Motor auto-tuning failure

Er.111: Servo internal parameters abnormal

Chapter 6 Parameter Table

The abbreviations in the parameter table are described as follows:

Type	Abbre-iation	Meaning
Property ("Pro")	Ru	It is possible to modify the parameter with the drive in the Running status.
	St	It is not possible to modify the parameter with the drive in the Stop status.
	Dp	The parameter is the actual measured value and can only be Displayed.
Effective time ("ET")	Im	Modification on the parameter takes effect Immediately.
	Po	Modification on the parameter takes effect upon Power-on again.
	St	Modification on the parameter takes effect upon Stop.

Control mode: CM; Reference unit: Ref; Enc: Enc

Group H00: Servo Motor Parameters

Function Code	Parameter Name	Setting Range	Unit	Default	ET	Pro	CM
H00-00	Motor SN	14000: Inovance 20-bit incremental encoder motor 14101: Inovance 23-bit absolute encoder motor	-	14000	Po	St	ALL
H00-02	Customized firmware version	-	-	-	-	Dp	-
H00-04	Encoder version	-	-	-	-	Dp	-
H00-05	Serial encoder motor SN	-	-	-	-	Dp	-
H00-09	Rated voltage	0: 220; 1: 380	V	-	Po	St	-
H00-10	Rated power	0.01 to 655.35	kW	-	Po	St	-
H00-11	Rated current	0.01 to 655.35	A	-	Po	St	-
H00-12	Rated torque	0.01 to 655.35	Nm	-	Po	St	-
H00-13	Max. torque	0.10 to 655.35	Nm	-	Po	St	-
H00-14	Rated motor speed	100 to 6000	RPM	-	Po	St	-
H00-15	Max. motor speed	100 to 6000	RPM	-	Po	St	-
H00-16	Rotor inertia Jm	0.01 to 655.35	kgcm ²	-	Po	St	-
H00-17	Number of pole pairs of PMSM	2 to 360	Pole-pair	-	Po	St	-
H00-18	Stator resistance	0.001 to 65.535	Ω	-	Po	St	-
H00-19	Stator inductance Lq	0.01 to 655.35	mH	-	Po	St	-
H00-20	Stator inductance Ld	0.01 to 655.35	mH	-	Po	St	-
H00-21	Linear back EMF coefficient	0.01 to 655.35	mV/RPM	-	Po	St	-
H00-22	Torque coefficient Kt	0.01 to 655.35	Nm/Arms	-	Po	St	-
H00-23	Electrical constant Te	0.01 to 655.35	ms	-	Po	St	-
H00-24	Mechanical constant Tm	0.01 to 655.35	ms	-	Po	St	-
H00-28	Position offset of absolute encoder	0 to 1073741824	P/r	-	Po	St	-

Function Code	Parameter Name	Setting Range	Unit	Default	ET	Pro	CM
H00-30	Encoder selection (Hex)	0x000: Common incremental encoder (UVW-ABZ) 0x013: Inovance 20-bit serial encoder	1	0x013	Po	St	-
H00-31	PPR of encoder	0 to 1073741824	P/r	1048576	Po	St	-
H00-33	Electrical angle of signal Z	0.0 to 360	°	180	Po	St	-
H00-34	Electrical angle of phase U rise edge	0.0 to 360	°	180	Po	St	-

Group H01: Servo Drive Parameters

Function Code	Parameter Name	Setting Range	Unit	Default	ET	Pro	CM
H01-00	MCU firmware version	0 to 65535	-	-	-	Dp	-
H01-01	FPGA firmware version	0 to 65535	-	-	-	Dp	-
H01-02	Servo drive SN	0 to 65535	-	-	Po	St	-

Group H02: Basic Control Parameters

Function Code	Parameter Name	Setting Range	Unit	Default	ET	Pro	CM
H02-00	Control mode selection	0: Speed mode 1: Position mode 2: Torque mode 3: Torque mode/Speed mode 4: Speed mode/Position mode 5: Torque mode/Position mode 6: Torque mode/Speed mode/Position mode	-	1	Im	St	-
H02-01	Absolute system selection	0: Incremental position mode 1: Absolute position linear mode 2: Absolute position rotating mode	-	0	Po	St	ALL
H02-02	Rotating direction selection	0: CCW direction as forward direction (phase A advancing phase B) 1: CW direction as forward direction (phase A lagging phase B)	-	0	Po	St	PST
H02-03	Output pulse phase	0: CCW direction as forward direction (phase A advancing phase B) 1: CW direction as forward direction (phase A lagging phase B)	-	0	Po	St	PST
H02-05	Stop mode at S-ON off	0: Coast to stop, keeping de-energized state 1: Emergency stop, keeping de-energized state	-	0	Im	St	PST
H02-06	Stop mode at NO.2 fault	0: Coast to stop, keeping de-energized state 1: Emergency stop, keeping de-energized state	-	0	Im	St	PST

Function Code	Parameter Name	Setting Range	Unit	Default	ET	Pro	CM
H02-07	Stop mode at limit switch signal	0: Coast to stop, keeping de-energized state 1: Emergency stop, keeping position locking state 2: Emergency stop, keeping de-energized state	-	1	Im	St	PST
H02-08	Stop mode at NO.1 fault	0: Coast to stop, keeping de-energized state	-	0	Im	St	PST
H02-09	Delay from brake output ON to command received	0 to 500	ms	250	Im	Ru	PS
H02-10	Delay from brake output OFF to motor de-energized in static state	1 to 1000	ms	150	Im	Ru	PS
H02-11	Motor speed threshold at brake output OFF in rotating state	0 to 3000	RPM	30	Im	Ru	PS
H02-12	Delay from brake output OFF to motor de-energized in rotating state	1 to 1000	ms	500	Im	Ru	PS
H02-15	Warning display on keypad	0: Output warning information immediately 1: Not output warning information	-	0	Im	St	PST
H02-18	Filter time of S-ON signal	0 to 64	ms	0	Im	St	PST
H02-21	Permissible minimum resistance of regenerative resistor	-	Ω	-	-	Dp	PST
H02-22	Power of built-in regenerative resistor	-	W	-	-	Dp	PST
H02-23	Resistance of built-in regenerative resistor	-	Ω	-	-	Dp	PST
H02-24	Resistor heat dissipation coefficient	10 to 100	%	30	Im	St	PST
H02-25	Regenerative resistor type	0: Built-in 1: External, naturally ventilated 2: External, forcible cooling 3: No resistor, using only capacitor	-	0	Im	St	PST
H02-26	Power of external regenerative resistor	1 to 65535	W	-	Im	St	PST
H02-27	Resistance of external regenerative resistor	1 to 1000	Ω	-	Im	St	PST
H02-30	User password	0 to 65535	-	0	Po	St	PST
H02-31	Parameter initialization	0: No operation 1: Restore default setting (except the parameters in groups H00 and H01.) 2: Clear fault records	-	0	Im	St	PST
H02-32	Default keypad display	0 to 99	-	50	Im	Ru	-
H02-33	EtherCAT software version	-	-	-	-	Dp	-
H02-34	CAN firmware version	-	-	-	-	Dp	-
H02-38	Braking time at short-circuit	0 to 30000	ms	5000	Im	St	S

Function Code	Parameter Name	Setting Range	Unit	Default	ET	Pro	CM
H02-39	Maximum braking current at short-circuit	0 to 3000	0.1%	1000	Im	St	S

Group H03: Input Terminal Parameters

Function Code	Parameter Name	Setting Range	Unit	Default	ET	Pro	CM
H03-00	DI function (active after power-on) allocation 1	0-0xFFFF Bit0: FunIN.1; Bit1: FunIN.2Bit15: FunIN.16	-	0	Po	Ru	-
H03-01	DI function (active after power-on) allocation 2	0-0xFFFF Bit0: FunIN.17; Bit1: FunIN.18Bit15: FunIN.32	-	0	Po	Ru	-
H03-02	DI1 function selection	0 to 37	-	14	St	Ru	-
H03-03	DI1 logic selection	Input polarity: 0 to 4 0: Low level valid 1: High level valid 2: Rising edge valid 3: Falling edge valid 4: Rising edge and falling edge both valid	-	0	St	Ru	-
H03-04	DI2 function selection	0 to 37	-	15	St	Ru	-
H03-05	DI2 logic selection	Input polarity: 0 to 4 0: Low level valid 1: High level valid 2: Rising edge valid 3: Falling edge valid 4: Rising edge and falling edge both valid	-	0	St	Ru	-
H03-06	DI3 function selection	0 to 37	-	13	St	Ru	-
H03-07	DI3 logic selection	Input polarity: 0 to 4 0: Low level valid 1: High level valid 2: Rising edge valid 3: Falling edge valid 4: Rising edge and falling edge both valid	-	0	St	Ru	-
H03-08	DI4 function selection	0 to 37	-	2	St	Ru	-
H03-09	DI4 logic selection	Input polarity: 0 to 4 0: Low level valid 1: High level valid 2: Rising edge valid 3: Falling edge valid 4: Rising edge and falling edge both valid	-	0	St	Ru	-
H03-10	DI5 function selection	0 to 37	-	1	St	Ru	-
H03-11	DI5 logic selection	Input polarity: 0 to 4 0: Low level valid 1: High level valid 2: Rising edge valid 3: Falling edge valid 4: Rising edge and falling edge both valid	-	0	St	Ru	-
H03-12	DI6 function selection	0 to 37	-	12	St	Ru	-

Function Code	Parameter Name	Setting Range	Unit	Default	ET	Pro	CM
H03-13	DI6 logic selection	Input polarity: 0 to 4 0: Low level valid 1: High level valid 2: Rising edge valid 3: Falling edge valid 4: Rising edge and falling edge both valid	-	0	St	Ru	-
H03-14	DI7 function selection	0 to 37	-	3	St	Ru	-
H03-15	DI7 logic selection	Input polarity: 0 to 4 0: Low level valid 1: High level valid 2: Rising edge valid 3: Falling edge valid 4: Rising edge and falling edge both valid	-	0	St	Ru	-
H03-16	DI8 function selection	0 to 37	-	31	St	Ru	-
H03-17	DI8 logic selection	Input polarity: 0 to 4 0: Low level valid 1: High level valid 2: Rising edge valid 3: Falling edge valid 4: Rising edge and falling edge both valid	-	0	St	Ru	-
H03-18	DI9 function selection	0 to 37	-	0	St	Ru	-
H03-19	DI9 logic selection	Input polarity: 0 to 4 0: Low level valid 1: High level valid 2: Rising edge valid 3: Falling edge valid 4: Rising edge and falling edge both valid	-	0	St	Ru	-
H03-34	DI function (active after power-on) allocation 3	0 to 0xFFFF Bit0: FunIN.33; Bit1: FunIN.34Bit15: FunIN.48	-	0	Po	Ru	-
H03-35	DI function (active after power-on) allocation 4	0 to 0xFFFF Bit0: FunIN.49; Bit1: FunIN.50Bit15: FunIN.64	-	0	Po	Ru	-
H03-50	AI1 offset	-5000 to 5000	mV	0	Im	Ru	-
H03-51	AI1 filter time constant	0 to 655.35	ms	2.00	Im	Ru	-
H03-53	AI1 dead zone	0 to 1000.0	mV	10.0	Im	Ru	-
H03-54	AI1 zero drift	-500.0 to 500.0	mV	0.0	Im	Ru	-
H03-55	AI2 offset	-5000 to 5000	mV	0	Im	Ru	-
H03-56	AI2 filter time constant	0 to 655.35	ms	2.00	Im	Ru	-
H03-58	AI2 dead zone	0 to 1000.0	mV	10.0	Im	Ru	-
H03-59	AI2 zero drift	-500.0 to 500.0	mV	0.0	Im	Ru	-
H03-80	Speed corresponding to 10 V	0 to 9000	RPM	3000 RPM	Im	St	-
H03-81	Torque corresponding to 10 V	1.00 to 8.00 times of rated torque	1.00	1.00	Im	St	-

Group H04: Output Terminal Parameters

Function Code	Parameter Name	Setting Range	Unit	Default	ET	Pro	CM
H04-00	DO1 function selection	0 to 22	-	1	St	Ru	-
H04-01	DO1 logic selection	0: Output low level when valid (optocoupler ON) 1: Output high level when valid (optocoupler OFF)	-	0	St	Ru	-
H04-02	DO2 function selection	0 to 22	-	5	St	Ru	-
H04-03	DO2 logic selection	0: Output low level when valid (optocoupler ON) 1: Output high level when valid (optocoupler OFF)	-	0	St	Ru	-
H04-04	DO3 function selection	0 to 22	-	3	St	Ru	-
H04-05	DO3 logic selection	0: Output low level when valid (optocoupler ON) 1: Output high level when valid (optocoupler OFF)	-	0	St	Ru	-
H04-06	DO4 function selection	0 to 22	-	11	St	Ru	-
H04-07	DO4 logic selection	0: Output low level when valid (optocoupler ON) 1: Output high level when valid (optocoupler OFF)	-	0	St	Ru	-
H04-08	DO5 function selection	0 to 22	-	16	St	Ru	-
H04-09	DO5 logic selection	0: Output low level when valid (optocoupler ON) 1: Output high level when valid (optocoupler OFF)	-	0	St	Ru	-
H04-22	DO source	0 to 31	-	0	Im	St	-
H04-50	AO1 signal selection	00: Motor speed (1 V/1000 RPM) 01: Speed reference (1 V/1000 RPM) 02: Torque reference (1 V/1 time of rated motor torque) 03: Position deviation (0.05 V/1 reference unit) 04: Position deviation (0.05 V/Enc) 05: Position reference speed (1 V/1000 RPM) 06: Positioning completed (positioning completed: 5 V, positioning not completed: 0 V) 07: Speed feedforward (1 V/1000 RPM) 08: AI1 voltage 09: AI2 voltage	-	0	Im	Ru	-
H04-51	AO1 offset voltage	-10000 to 10000	mV	5000	Im	Ru	-
H04-52	AO1 multiplying factor	-99.99 to 99.99	times	1.00	Im	Ru	-

Function Code	Parameter Name	Setting Range	Unit	Default	ET	Pro	CM
H04-53	AO2 signal selection	00: Motor speed (1 V/1000 RPM) 01: Speed reference (1 V/1000 RPM) 02: Torque reference (1 V/1 time of rated motor torque) 03: Position deviation (0.05 V/1 reference unit) 04: Position deviation (0.05 V/Enc) 05: Position reference speed (1 V/1000 RPM) 06: Positioning completed (positioning completed: 5 V, positioning not completed: 0 V) 07: Speed feedforward (1 V/1000 RPM) 08: AI1 voltage 09: AI2 voltage	-	0	Im	Ru	-
H04-54	AO2 offset voltage	-10000 to 10000	mV	5000	Im	Ru	-
H04-55	AO2 multiplying factor	-99.99 to 99.99	times	1.00	Im	Ru	-

Group H05: Position Control Parameters

Function Code	Parameter Name	Setting Range	Unit	Default	ET	Pro	CM
H05-00	Position reference source	0: Pulse input 1: Step setting 2: Multi-position reference	-	0	Im	St	P
H05-01	Pulse input terminal selection	0: Low-speed terminals 1: High-speed terminals	-	0	Im	St	P
H05-02	Pulses per one motor revolution	0 to 1048576	P/r	0	Po	St	P
H05-04	Time constant of first-order low-pass filter	0 to 6553.5	ms	0.0	Im	St	P
H05-05	Step amount	-9999 to 9999	Ref	50	Im	St	P
H05-06	Time constant of moving average filter	0.0 to 128.0	ms	0.0	Im	St	P
H05-07	Electronic gear ratio 1 (numerator)	1 to 1073741824	-	1048576	Im	Ru	P
H05-09	Electronic gear ratio 1 (denominator)	1 to 1073741824	-	10000	Im	Ru	P
H05-11	Electronic gear ratio 2 (numerator)	1 to 1073741824	-	1048576	Im	Ru	P
H05-13	Electronic gear ratio 2 (denominator)	1 to 1073741824	-	10000	Im	Ru	P

Function Code	Parameter Name	Setting Range	Unit	Default	ET	Pro	CM
H05-15	Pulse input format	0: Pulse + direction, positive logic 1: Pulse + direction, negative logic 2: Phase A + phase B quadrature pulse, 4-frequency multiplication 3: CW + CCW	-	0	Po	St	P
H05-16	Clear action	0: Clear position deviation when S-ON is turned off or a fault occurs 1: Clear position deviation pulses when S-ON is turned off or a fault occurs 2: Clear position deviation when S-ON is turned off and the ClrPosErr signal is input from DI	-	0	Im	St	P
H05-17	Encoder frequency-division pulses	35 to 32767	P/r	2500	Po	St	-
H05-19	Speed feedforward control selection	0: No speed feedforward 1: Internal 2: AI1 3: AI2	-	1	Im	St	P
H05-20	Output condition of positioning completed/near signal (COIN)	0: Absolute value of position deviation is smaller than setting of H05-21/H05-22 1: Absolute value of position deviation is smaller than setting of H05-21/H05-22 and position reference after filter is 0 2: Absolute value of position deviation is smaller than setting of H05-21/H05-22 and position reference before filter is 0 3: Absolute value of position deviation is smaller than setting of H05-21/H05-22 and position reference is 0, positioning completed/near signal holding time determined by H05-60	-	0	Im	Ru	P
H05-21	Position deviation threshold of positioning completed	1 to 65535	Enc/Ref	734	Im	Ru	P
H05-22	Position deviation threshold of positioning near	1 to 65535	Enc/Ref	65535	Im	Ru	P
H05-23	Position change on fly	0: Disabled 1: Enabled	-	0	Po	St	P
H05-24	Displacement of position change on fly	0 to 1073741824	Ref	10000	Im	Ru	P
H05-26	Constant speed for position change on fly	0 to 6000	RPM	200	Im	Ru	P
H05-27	Acceleration/Deceleration time of position change on fly	0 to 1000	ms	10	Im	Ru	P
H05-29	Position change on fly unlock	0: Disabled 1: Enabled	-	1	Im	Ru	P

Function Code	Parameter Name	Setting Range	Unit	Default	ET	Pro	CM
H05-30	Homing enabling method	0: Disabled 1: Input HomingStart signal from DI to enable homing 2: Input HomingStart signal from DI to enable electrical home attaining 3: Start homing immediately upon power-on 4: Perform homing immediately 5: Start electrical home attaining 6: Take current position as the home	-	0	Im	Ru	P
H05-31	Homing mode	0: Forward direction, deceleration point and home being home switch signal 1: Reverse direction, deceleration point and home being home switch signal 2: Forward direction, deceleration point and home being motor Z signal 3: Reverse direction, deceleration point and home being motor Z signal 4: Forward direction, deceleration point being home switch signal and home being motor Z signal 5: Reverse direction, deceleration point being home switch signal and home being motor Z signal 6: Forward direction, deceleration point and home being forward limit switch signal 7: Reverse direction, deceleration point and home being reverse limit switch signal 8: Forward direction, deceleration point being forward limit switch signal and home being motor Z signal 9: Reverse direction, deceleration point being reverse limit switch signal and home being motor Z signal (to be continued)	-	0	Im	St	P
H05-31	Homing mode	10: Forward direction, deceleration point being mechanical final limit position and home being mechanical final limit position 11: Reverse direction, deceleration point being mechanical final limit position and home being mechanical final limit position 12: Forward direction, deceleration point being mechanical final limit position and home being motor Z signal 13: Reverse direction, Mechanical final limit position and home being motor Z signal	-	0	Im	St	P
H05-32	Low speed of homing	0 to 3000	RPM	100	Im	Ru	P
H05-33	High speed of homing	0 to 1000	RPM	10	Im	Ru	P
H05-34	Acceleration/ Deceleration time of homing	0 to 1000	ms	1000	Im	St	P
H05-35	Duration limit of homing	0 to 65535	ms	10000	Im	St	P
H05-36	Mechanical home offset	-1073741824 to 1073741824	Ref	0	Im	St	P

Function Code	Parameter Name	Setting Range	Unit	Default	ET	Pro	CM
H05-38	Servo pulse output source	0: Encoder frequency-division output 1: Pulse synchronous output 2: Frequency-division or synchronous output inhibited	-	0	Po	St	P
H05-39	Electronic gear ratio switchover condition	0: Switchover if position reference (reference unit) = 0 and the duration reaches 2.5 ms 1: Real-time switchover	-	0	Im	St	P
H05-40	Mechanical home offset and action after reaching limit switch	0: H05-36 as coordinate for homing, trigger homing and find home reversely after reaching limit switch 1: H05-36 as relative offset for homing, trigger homing and find home reversely after reaching limit switch 2: H05-36 as coordinate for homing, automatically find zero position reversely after reaching limit switch 3: H05-36 as relative offset for homing, automatically find zero position reversely after reaching limit switch	-	0	Im	St	P
H05-41	Output polarity of Z pulse	0: Positive (high level when pulse Z is valid) 1: Negative (low level when pulse Z is valid)	-	1	Po	St	P
H05-46	Position offset in absolute position linear mode (low 32 bits)	-2147483648 to 2147483647	Enc	0	Po	St	PST
H05-48	Position offset in absolute position linear mode (high 32 bits)	-2147483648 to 2147483647	Enc	0	Po	St	PST
H05-50	Mechanical gear ratio in absolute position rotating mode (numerator)	1 to 65535	1	65535	Im	St	ALL
H05-51	Mechanical gear ratio in absolute position rotating mode (denominator)	1 to 65535	1	1	Im	St	ALL
H05-52	Pulses within one revolution of load in absolute position rotating mode (low 32 bits)	0 to 4294967295	Enc	0	Im	St	ALL
H05-54	Pulses within one revolution of load in absolute position rotating mode (high 32 bits)	0 to 127	Enc	0	Im	St	ALL
H05-56	Judgment threshold of homing with hit & stop	0 to 1000	RPM	2	Im	Ru	P
H05-58	Torque limit of homing with hit & stop	0 to 300.0	%	100.0	Im	Ru	P
H05-59	Time threshold of positioning completed	1 to 30000	ms	0	Im	Ru	P
H05-60	Positioning completed holding time	1 to 30000	ms	1	Im	Ru	P
H05-61	Encoder frequency-division pulses (32-bit)	0 to 262143	P/r	0	Po	Ru	-

Group H06: Speed Control Parameters

Function Code	Parameter Name	Setting Range	Unit	Default	ET	Pro	CM
H06-00	Main speed reference A source	0: Digital setting (H06-03) 1: AI1 2: AI2	-	0	Im	St	S
H06-01	Auxiliary speed reference B source	0: Digital setting (H06-03) 1: AI1 2: AI2 3: 0 (invalid) 4: 0 (invalid) 5: Multi-speed reference	-	1	Im	St	S
H06-02	Speed reference source selection	0: Main speed reference A source 1: Auxiliary speed reference B source 2: A + B 3: A/B switchover 4: Communication setting	-	0	Im	St	S
H06-03	Keypad setting value of speed reference	-6000 to 6000	RPM	200	Im	Ru	S
H06-04	Jog speed setting value	0 to 6000	RPM	100	Im	Ru	S
H06-05	Acceleration ramp time constant of speed reference	0 to 65535	ms	0	Im	Ru	S
H06-06	Deceleration ramp time constant of speed reference	0 to 65535	ms	0	Im	Ru	S
H06-07	Maximum speed limit	0 to 6000	RPM	6000	Im	Ru	S
H06-08	Positive speed limit	0 to 6000	RPM	6000	Im	Ru	S
H06-09	Negative speed limit	0 to 6000	RPM	6000	Im	Ru	S
H06-11	Torque feedforward control selection	0: No torque feedforward 1: Internal torque feedforward	-	1	Im	Ru	PS
H06-15	Speed threshold for zero speed clamp	0 to 6000	RPM	10	Im	Ru	S
H06-16	Speed threshold of motor rotation signal	0 to 1000	RPM	20	Im	Ru	S
H06-17	Threshold of speed consistent signal	0 to 100	RPM	10	Im	Ru	S
H06-18	Threshold of speed reached signal	10 to 6000	RPM	1000	Im	Ru	S
H06-19	Threshold of zero speed output signal	1 to 6000	RPM	10	Im	Ru	S

6

Group H07: Torque Control Parameters

Torque reference 100% corresponds to rated motor torque.

Function Code	Parameter Name	Setting Range	Unit	Default	ET	Pro	CM
H07-00	Main torque reference A source	0: Digital setting (H07-03) 1: AI1 2: AI2	-	0	Im	St	T

6 Parameter Table

Function Code	Parameter Name	Setting Range	Unit	Default	ET	Pro	CM
H07-01	Auxiliary torque reference B source	0: Digital setting (H07-03) 1: AI1 2: AI2	-	1	Im	St	T
H07-02	Torque reference source	0: Main torque reference A source 1: Auxiliary torque reference B source 2: A + B 3: A/B switchover 4: Communication setting	-	0	Im	St	T
H07-03	Keypad setting value of torque reference	-300.0 to 300.0	%	0	Im	Ru	T
H07-05	Time constant of torque reference filter	0 to 30.00	ms	0.79	Im	Ru	PST
H07-06	2nd time constant of torque reference filter	0 to 30.00	ms	0.79	Im	Ru	PST
H07-07	Torque limit source	0: Internal positive/negative torque limit 1: External positive/negative torque limit (via P-CL, N-CL) 2: T-LMT as external torque limit 3: Minimum of external positive/negative torque and external T-LMT as torque limit (via P-CL, N-CL) 4: Switchover between internal positive/negative torque limit and T-LMT torque limit (via P-CL, N-CL)	-	0	Im	St	PST
H07-08	T-LMT selection	1: AI1 2: AI2	-	2	Im	St	PST
H07-09	Internal positive torque limit	0.0 to 300.0	%	300.0	Im	Ru	PST
H07-10	Internal negative torque limit	0.0 to 300.0	%	300.0	Im	Ru	PST
H07-11	External positive torque limit	0.0 to 300.0	%	300.0	Im	Ru	PST
H07-12	External negative torque limit	0.0 to 300.0	%	300.0	Im	Ru	PST
H07-17	Speed limit source	0: Internal speed limit (in torque control) 1: V-LMT as external speed limit 2: Speed limit selected via DI	-	0	Im	Ru	T
H07-18	V-LMT selection	1: AI1 2: AI2	-	1	Im	Ru	T
H07-19	Positive speed limit/1st speed limit in torque control	0 to 6000	RPM	3000	Im	Ru	T
H07-20	Negative speed limit/2nd speed limit in torque control	0 to 6000	RPM	3000	Im	Ru	T
H07-21	Base value for torque reached	0.0 to 300.0	%	0.0	Im	Ru	PST
H07-22	Threshold of torque reached valid	0.0 to 300.0	%	20.0	Im	Ru	PST
H07-23	Threshold of torque reached invalid	0.0 to 300.0	%	10.0	Im	Ru	PST
H07-40	Speed limit window in the torque control mode	0.5 to 30.0	ms	1.0	Im	Ru	T

Group H08: Gain Parameters

Function Code	Parameter Name	Setting Range	Unit	Default	ET	Pro	CM
H08-00	Speed loop gain	0.1 to 2000.0	Hz	25.0	Im	Ru	PS
H08-01	Time constant of speed loop integration	0.15 to 512.00	ms	31.83	Im	Ru	PS
H08-02	Position loop gain	0.0 to 2000.0	Hz	40.0	Im	Ru	P
H08-03	2nd gain of speed loop	0.1 to 2000.0	Hz	40.0	Im	Ru	PS
H08-04	2nd time constant of speed loop integration	0.15 to 512.00	ms	40.00	Im	Ru	PS
H08-05	2nd gain of position loop	0.0 to 2000.0	Hz	64.0	Im	Ru	P
H08-08	2nd gain mode setting	0: Always use the first gain, P/PI switched over via DI 1: First gain and second gain switched over according to the setting of H08-09	-	1	Im	Ru	PST
H08-09	Gain switchover condition	0: Fixed at 1st gain (PS) 1: Switched over via DI (PS) 2: Torque reference being large (PS) 3: Speed reference being large (PS) 4: Speed reference change rate being large (PS) 5: Speed reference high-speed low-speed thresholds (PS) 6: Position deviation being large (P) 7: Position reference available (P) 8: Positioning completed (P) 9: Motor speed being large (P) 10: Position reference available + motor speed (P)	-	0	Im	Ru	PST
H08-10	Gain switchover delay	0.0 to 1000.0	ms	5.0	Im	Ru	PST
H08-11	Gain switchover level	0 to 20000	*	50	Im	Ru	PST
H08-12	Gain switchover hysteresis	0 to 20000	*	30	Im	Ru	PST
H08-13	Position gain switchover time	0.0 to 1000.0	ms	3.0	Im	Ru	P
H08-15	Load inertia ratio	0.00 to 120.00	Times	1.00	Im	Ru	PST
H08-18	Time constant of speed feedforward filter	0.00 to 64.00	ms	0.50	Im	Ru	P
H08-19	Speed feedforward gain	0.0 to 100.0	%	0.0	Im	Ru	P
H08-20	Time constant of torque feedforward filter	0.00 to 64.00	ms	0.50	Im	St	PS
H08-21	Torque feedforward gain	0.0 to 200.0	%	0.0	Im	Ru	PS
H08-22	Speed feedback filter	0: Disabled 1: Mean filter of 2 speed feedbacks 2: Mean filter of 4 speed feedbacks 3: Mean filter of 8 speed feedbacks 4: Mean filter of 16 speed feedbacks	-	0	Im	St	PS

Function Code	Parameter Name	Setting Range	Unit	Default	ET	Pro	CM
H08-23	Cutoff frequency of speed feedback low-pass filter	100 to 4000	Hz	4000	Im	Ru	PS
H08-24	PDF control coefficient	0.0 to 100.0	-	100.0	Im	Ru	PS

*: Based on switchover condition

Group H09: Automatic Gain Tuning Parameters

Function Code	Parameter Name	Setting Range	Unit	Default	ET	Pro	CM
H09-00	Automatic gain tuning mode selection	0: Disabled, gain parameters are set manually 1: Automatic gain tuning mode, gain parameters tuned automatically based on stiffness table 2: Positioning mode, gain parameters tuned automatically based on stiffness table	-	0	Im	Ru	PST
H09-01	Stiffness level selection	0 to 31	-	12	Im	Ru	PST
H09-02	Mode selection of adaptive notch	0: Parameters not updated 1: Only one notch (3rd notch) valid, parameters updated in real time 2: Both notches (3rd and 4th notches) valid, parameters updated in real time 3: Only detect resonance frequency (displayed in H09-24) 4: Clear 3rd and 4th notches, restore parameters to default setting	-	0	Im	Ru	PST
H09-03	Online inertia auto-tuning mode	0: Disabled 1: Enabled, update slowly 2: Enabled, always update 3: Enabled, update quickly	-	0	Im	Ru	RST
H09-04	Suppression mode of low-frequency resonance	0: Manually set parameters of low-frequency resonance suppression filter (H09-38 and H09-39) 1: Automatically set parameters of low-frequency resonance suppression filter (H09-38 and H09-39)	-	0	Im	Ru	P
H09-05	Offline inertia auto-tuning mode	0: Positive and negative triangular wave mode 1: Jog mode	-	0	Im	St	PST
H09-06	Maximum speed for inertia auto-tuning	100 to 1000	RPM	500	Im	St	PST
H09-07	Time constant of accelerating to max. speed for inertia auto-tuning	20 to 800	ms	125	Im	St	PST
H09-08	Interval after an inertia auto-tuning	50 to 10000	ms	800	Im	St	PST
H09-09	Motor revolutions for an inertia auto-tuning	0.00 to 2.00	r	-	-	D	PST

Function Code	Parameter Name	Setting Range	Unit	Default	ET	Pro	CM
H09-12	1st notch frequency	50 to 4000	Hz	4000	Im	Ru	PS
H09-13	1st notch width level	0 to 20	-	2	Im	Ru	PS
H09-14	1st notch depth level	0 to 99	-	0	Im	Ru	PS
H09-15	2nd notch frequency	50 to 4000	Hz	4000	Im	Ru	PS
H09-16	2nd notch width level	0 to 20	-	2	Im	Ru	PS
H09-17	2nd notch depth level	0 to 99	-	0	Im	Ru	PS
H09-18	3rd notch frequency	50 to 4000	Hz	4000	Im	Ru	PS
H09-19	3rd notch width level	0 to 20	-	2	Im	Ru	PS
H09-20	3rd notch depth level	0 to 99	-	0	Im	Ru	PS
H09-21	4th notch frequency	50 to 4000	Hz	4000	Im	Ru	PS
H09-22	4th notch width level	0 to 20	-	2	Im	Ru	PS
H09-23	4th notch depth level	0 to 99	-	0	Im	Ru	PS
H09-24	Obtained resonance frequency	0 to 2	Hz	0	-	D	PS
H09-30	Torque disturbance compensation gain	0.0 to 100.0	%	0.0	Im	Ru	PS
H09-31	Time constant of torque disturbance observer filter	0.00 to 25.00	ms	0.50	Im	Ru	PS
H09-38	Frequency of low-frequency resonance	1.0 to 100.0	Hz	100.0	Im	Ru	P
H09-39	Filter setting of low-frequency resonance	0 to 10	-	2	Im	Ru	P

Group H0A: Fault and Protection Parameters

Function Code	Parameter Name	Setting Range	Unit	Default	ET	Pro	CM
H0A-00	Power input phase loss protection	0: Enable faults and inhibit warnings 1: Enable faults and warnings 2: Inhibit faults and warnings	-	0	Im	Ru	-
H0A-03	Retentive at power failure	0: Disabled 1: Enabled	-	0	Im	Ru	-
H0A-04	Motor overload protection gain	50 to 300	%	100	Im	St	-
H0A-08	Overspeed threshold	0 to 10000	RPM	0	Im	Ru	PST
H0A-09	Maximum position pulse frequency	100 to 4000	kHz	4000	Im	St	P
H0A-10	Threshold of position deviation excess	1 to 1073741824	Enc/ Ref	3145728	Im	Ru	P
H0A-12	Runaway protection function	0: Disabled 1: Enabled	-	1	Im	Ru	PST
H0A-16	Position deviation threshold for low-frequency resonance suppression	1 to 1000	Enc	5	Im	Ru	P

6 Parameter Table

Function Code	Parameter Name	Setting Range	Unit	Default	ET	Pro	CM
H0A-17	Position setting unit	0: Encoder unit 1: Reference unit	-	0	Im	St	P
H0A-19	DI8 filter time constant	0 to 255	25 ns	80	Po	St	-
H0A-20	DI9 filter time constant	0 to 255	25 ns	80	Po	St	-
H0A-24	Filter time constant of low-speed pulse input terminal	0 to 255	25 ns	30	Po	St	P
H0A-25	Filter time constant of speed feedback display	0 to 5000	ms	50	Im	St	-
H0A-26	Motor overload shielding	0: Motor overload detection enabled 1: Detection of motor overload warning (Er.909) and fault (Er.620) disabled	-	0	Im	St	-
H0A-27	Filter time constant of speed DO	0 to 5000	ms	10	Im	St	-
H0A-28	Filter time constant of quadrature encoder	0 to 255	25 ns	30	Po	St	-
H0A-30	Filter time constant of high-speed pulse input terminal	0 to 255	25ns	3	Po	St	P
H0A-32	Time threshold for locked rotor over-temperature protection	10 to 65535	ms	200	Im	Ru	-
H0A-33	Locked rotor over-temperature protection	0: Shield detection (Er.630) 1: Enable detection (Er.630)	-	1	Im	Ru	-
H0A-36	Encoder multi-turn overflow fault selection	0: Not shield fault 1: Shield fault	-	0	Im	St	ALL
H0A-40	Soft limit function	0: Disabled 1: Enabled immediately after power-on 2: Enabled after homing	1	0	Im	St	PST
H0A-41	Soft limit maximum value	-2147483648 to 2147483647	Ref	2147483647	Im	St	PST
H0A-43	Soft limit minimum value	-2147483648 to 2147483647	Ref	-2147483648	Im	St	PST
H0A-47	Brake protection detection function	0: Disabled 1: Enabled	-	0	Im	Ru	ALL
H0A-48	Gravity load detection value	0 to 300.0	%	30.0	Im	Ru	ALL

6

Group H0B: Monitoring Parameters

Function Code	Parameter Name	Setting Range	Unit	Default	ET	Pro	CM
H0B-00	Actual motor speed	-	RPM	-	-	Dp	PST
H0B-01	Speed reference	-	RPM	-	-	Dp	PS
H0B-02	Internal torque reference	-	%	-	-	Dp	PST
H0B-03	Monitored DI states	-	-	-	-	Dp	PST
H0B-05	Monitored DO states	-	-	-	-	Dp	PST

Function Code	Parameter Name	Setting Range	Unit	Default	ET	Pro	CM
H0B-07	Absolute position counter	-	Ref	-	-	Dp	PST
H0B-09	Mechanical angle	-	Enc	-	-	Dp	PST
H0B-10	Electric angle	-	°	-	-	Dp	PST
H0B-11	Speed corresponding to input position reference	-	RPM	-	-	Dp	P
H0B-12	Average load ratio	-	%	-	-	Dp	PST
H0B-13	Input position reference counter	-	Ref	-	-	Dp	P
H0B-15	Encoder position deviation counter	-	Enc	-	-	Dp	P
H0B-17	Feedback pulse counter	-	Enc	-	-	Dp	PST
H0B-19	Total power-on time	-	s	-	-	Dp	PST
H0B-21	AI1 sampling voltage	-	V	-	-	Dp	PST
H0B-22	AI2 sampling voltage	-	V	-	-	Dp	PST
H0B-24	Phase current effective value	-	A	-	-	Dp	PST
H0B-26	Bus voltage	-	V	-	-	Dp	PST
H0B-27	Module temperature	-	°C	-	-	Dp	PST
H0B-33	Fault record	0: Current fault 1: Latest fault 2: Last 2nd fault 9: Last 9nd fault	-	0	Im	Ru	PST
H0B-34	Fault code of selected fault record	-	-	-	-	Dp	PST
H0B-35	Time stamp upon displayed fault	-	s	-	-	Dp	PST
H0B-37	Motor speed upon displayed fault	-	RPM	-	-	Dp	PST
H0B-38	Motor phase U current upon displayed fault	-	A	-	-	Dp	PST
H0B-39	Motor phase V current upon displayed fault	-	A	-	-	Dp	PST
H0B-40	Bus voltage upon displayed fault	-	V	-	-	Dp	PST
H0B-41	Input terminal state upon displayed fault	-	-	-	-	Dp	PST
H0B-42	Output terminal state upon displayed fault	-	-	-	-	Dp	PST
H0B-53	Position deviation counter	-	Ref	-	-	Dp	P
H0B-55	Actual motor speed	-	RPM	-	-	Dp	PST
H0B-58	Mechanical absolute position (low 32 bits)	-	Enc	0	-	Dp	ALL
H0B-60	Mechanical absolute position (high 32 bits)	-	Enc	0	-	Dp	ALL
H0B-64	Real-time input position reference counter	-	Ref	-	-	Dp	PST
H0B-70	Number of absolute encoder turns	-	r	0	-	Dp	ALL
H0B-71	Position of absolute encoder within one turn	-	Enc	0	-	Dp	ALL
H0B-77	Absolute position (low 32 bits) of absolute encoder)	-	Enc	0	-	Dp	ALL
H0B-79	Absolute position (high 32 bits) of absolute encoder	-	Enc	0	-	Dp	ALL
H0B-81	Rotating load single-turn position (low 32 bits)	-	Enc	0	-	Dp	ALL
H0B-83	Rotating load single-turn position (high 32 bits)	-	Enc	0	-	Dp	ALL

Function Code	Parameter Name	Setting Range	Unit	Default	ET	Pro	CM
H0B-85	Rotating load single-turn position	-	Enc	0	-	Dp	ALL

Group H0C: Communication Parameters

Function Code	Parameter Name	Setting Range	Unit	Default	ET	Pro	CM
H0C-00	Servo axis address	0: Broadcast address 1 to 247	-	1	Im	Ru	PST
H0C-02	Serial baud rate	0: 2400 Kbps; 1: 4800 Kbps 2: 9600 Kbps; 3: 19200 Kbps 4: 38400 Kbps; 5: 57600 Kbps	-	5	Im	Ru	PST
H0C-03	Modbus data format	0: No check, 2 stop bits 1: Even parity check, 1 stop bit 2: Odd parity check, 1 stop bit 3: No check, 1 stop bit	-	0	Im	Ru	PST
H0C-08	CAN communication rate	0: 20 K; 1: 50 K; 2: 100 K; 3: 125 K; 4: 250 K; 5: 500 K; 6: 1 M; 7: 1 M	-	5	Im	Ru	PST
H0C-09	Communication VDI	0: Disabled; 1: Enabled	-	0	Im	St	PST
H0C-10	VDI default value after power-on	Bit0: VDI1 default value Bit15: VDI16 default value	-	0	Po	Ru	PST
H0C-11	Communication VDO	0: Disabled; 1: Enabled	-	0	Im	St	PST
H0C-12	Default level of VDO allocated with function 0	Bit0: VDO1 default valueBit15: VDO16 default value	-	0	Im	St	PST
H0C-13	Update function code values written via communication to EEPROM	0: Not update the function codes written via communication to EEPROM 1: Update the function codes written via communication, except groups H0B and H0D to EEPROM	-	1	Im	Ru	PST
H0C-14	Modbus error code	New protocol: 0x0001: Illegal command code 0x0002: Illegal data address 0x0003: Illegal data 0x0004: Slave device fault Old protocol: 0x0002: Command code not being 0x03/0x06/0x10 0x0004: CRC checksum received and calculated by servo different from checksum in data frame 0x0008: Accessed function code not exist 0x0010: Written function code value exceed limits 0x0080: Written function code modifiable only in stop state but servo being in running state	1	-	-	Dp	-
H0C-25	Modbus response delay	0 to 5000	ms	1	Im	Ru	PST
H0C-26	Modbus communication data sequence	0: High 16 bits before low 16 bits 1: Low 16 bits before high 16 bits	1	1	Im	Ru	PST

Function Code	Parameter Name	Setting Range	Unit	Default	ET	Pro	CM
H0C-30	Modbus error frame format	0: Old protocol; 1: New protocol (standard)	1	1	Im	Ru	PST

Group H0D: Auxiliary Function Parameters

Function Code	Parameter Name	Setting Range	Unit	Default	ET	Pro	CM
H0D-00	Software reset	0: Disabled; 1: Enabled	-	0	Im	St	-
H0D-01	Fault reset	0: Disabled; 1: Enabled	-	0	Im	St	-
H0D-02	Offline inertia auto-tuning enable	-	-	-	Im	Ru	-
H0D-03	Reserved parameter	-	-	-	-	-	-
H0D-05	Emergency stop	0: Disabled 1: Enabled, stop mode determined in H02-05	-	0	Im	Ru	-
H0D-10	Analog automatic adjustment	0: Disabled; 1: AI1 adjustment; 2: AI2 adjustment	-	0	Im	St	-
H0D-11	Jog function	With filter	-	-	-	-	-
H0D-17	Forced DI/DO setting	0: Disabled 1: Forced DI enabled, forced DO disabled 2: Forced DO enabled, forced DI disabled 3: Forced DI and DO enabled	-	0	Im	Ru	-
H0D-18	Forced DI level	0 to 0x01FF	-	0x01FF	Im	Ru	-
H0D-19	Forced DO setting	0 to 0x001F	-	0	Im	Ru	-
H0D-20	Absolute encoder reset function	0: Disabled; 1: Reset faults; 2: Reset faults and multi-turn data	-	0	Im	Dp	ALL
H0D-24	Gravity load auto-tuning	0 to 1	-	0	Im	Ru	

Group H0F: Fully Closed-Loop Parameters

Function Code	Parameter Name	Setting Range	Unit	Default	ET	Pro	CM
H0F-00	Encoder feedback mode	0: Internal encoder feedback 1: External encoder feedback 2: Internal/External switchover at electronic gear ratio switchover	-	0	Im	St	P
H0F-01	Running direction of external encoder	0: Standard running direction 1: Reverse running direction	-	0	Im	St	P
H0F-04	External encoder pulses per one motor revolution	0 to 1073741824	Ext enc	10000	Po	St	P
H0F-08	Full closed-loop position deviation excess threshold	0 to 1073741824	Ext enc	10000	Im	Ru	P
H0F-10	Full closed-loop position deviation clear setting	0 to 100	r	0	Im	Ru	P

Function Code	Parameter Name	Setting Range	Unit	Default	ET	Pro	CM
H0F-13	Filter time constant of hybrid vibration suppression	0 to 6553.5	ms	0	Im	Ru	P
H0F-16	Full closed-loop position deviation counter	-1073741824 to 1073741824	Ext enc	0	-	D	P
H0F-18	Feedback pulse counter of internal encoder	-1073741824 to 1073741824	Int enc	0	-	D	P
H0F-20	Feedback pulse counter of external encoder	-1073741824 to 1073741824	Ext enc	0	-	D	P

Group H11: Multi-Position Function Parameters

Function Code	Parameter Name	Setting Range	Unit	Default	ET	Pro	CM
H11-00	Multi-position running mode	0: Stop after running single cycle 1: Cyclic running 2: DI switchover 3: Sequential running	-	1	Im	St	P
H11-01	Number of position reference profile	1 to 16	-	1	Im	St	P
H11-02	Margin processing method	0: Complete the remaining distance 1: Start running again from 1st position	-	0	Im	St	P
H11-03	Time unit	0: ms; 1: s	-	0	Im	St	P
H11-04	Displacement reference type	0: Relative displacement reference 1: Absolute displacement reference	-	0	Im	St	P
H11-05	Start position of sequential running	0 to 16	-	0	Im	St	P
H11-12	1st displacement	-1073741824 to 1073741824	Ref	10000	Im	Ru	P
H11-14	Maximum running speed of 1st displacement	1 to 6000	RPM	200	Im	Ru	P
H11-15	Acceleration/Deceleration time of 1st displacement	0 to 65535	ms (s)	10	Im	Ru	P
H11-16	Waiting time after 1st displacement	0 to 10000	ms (s)	10	Im	Ru	P
H11-17	2nd displacement	-1073741824 to 1073741824	Ref	10000	Im	Ru	P
H11-19	Maximum running speed of 2nd displacement	1 to 6000	RPM	200	Im	Ru	P
H11-20	Acceleration/Deceleration time of 2nd displacement	0 to 65535	ms (s)	10	Im	Ru	P
H11-21	Waiting time after 2nd displacement	0 to 10000	ms (s)	10	Im	Ru	P
H11-22	3rd displacement	-1073741824 to 1073741824	Ref	10000	Im	Ru	P
H11-24	Maximum running speed of 3rd displacement	1 to 6000	RPM	200	Im	Ru	P

Function Code	Parameter Name	Setting Range	Unit	Default	ET	Pro	CM
H11-25	Acceleration/Deceleration time of 3rd displacement	0 to 65535	ms (s)	10	Im	Ru	P
H11-26	Waiting time after 3rddisplacement	0 to 10000	ms (s)	10	Im	Ru	P
H11-27	4th displacement	-1073741824 to 1073741824	Ref	10000	Im	Ru	P
H11-29	Maximum running speed of 4th displacement	1 to 6000	RPM	200	Im	Ru	P
H11-30	Acceleration/Deceleration time of 4th displacement	0 to 65535	ms (s)	10	Im	Ru	P
H11-31	Waiting time after 4th displacement	0 to 10000	ms (s)	10	Im	Ru	P
H11-32	5th displacement	-1073741824 to 1073741824	Ref	10000	Im	Ru	P
H11-34	Maximum running speed of 5th displacement	1 to 6000	RPM	200	Im	Ru	P
H11-35	Acceleration/Deceleration time of 5th displacement	0 to 65535	ms (s)	10	Im	Ru	P
H11-36	Waiting time after 5th displacement	0 to 10000	ms (s)	10	Im	Ru	P
H11-37	6th displacement	-1073741824 to 1073741824	Ref	10000	Im	Ru	P
H11-39	Maximum running speed of 6th displacement	1 to 6000	RPM	200	Im	Ru	P
H11-40	Acceleration/Deceleration time of 6th displacement	0 to 65535	ms (s)	10	Im	Ru	P
H11-41	Waiting time after 6th displacement	0 to 10000	ms (s)	10	Im	Ru	P
H11-42	7th displacement	-1073741824 to 1073741824	Ref	10000	Im	Ru	P
H11-44	Maximum running speed of 7th displacement	1 to 6000	RPM	200	Im	Ru	P
H11-45	Acceleration/Deceleration time of 7th displacement	0 to 65535	ms (s)	10	Im	Ru	P
H11-46	Waiting time after 7th displacement	0 to 10000	ms (s)	10	Im	Ru	P
H11-47	8th displacement	-1073741824 to 1073741824	Ref	10000	Im	Ru	P
H11-49	Maximum running speed of 8th displacement	1 to 6000	RPM	200	Im	Ru	P
H11-50	Acceleration/Deceleration time of 8th displacement	0 to 65535	ms (s)	10	Im	Ru	P
H11-51	Waiting time after 8th displacement	0 to 10000	ms (s)	10	Im	Ru	P
H11-52	9th displacement	-1073741824 to 1073741824	Ref	10000	Im	Ru	P
H11-54	Maximum running speed of 9th displacement	1 to 6000	RPM	200	Im	Ru	P
H11-55	Acceleration/Deceleration time of 9th displacement	0 to 65535	ms (s)	10	Im	Ru	P
H11-56	Waiting time after 9th displacement	0 to 10000	ms (s)	10	Im	Ru	P

6 Parameter Table

Function Code	Parameter Name	Setting Range	Unit	Default	ET	Pro	CM
H11-57	10th displacement	-1073741824 to 1073741824	Ref	10000	Im	Ru	P
H11-59	Maximum running speed of 10th displacement	1 to 6000	RPM	200	Im	Ru	P
H11-60	Acceleration/Deceleration time of 10th displacement	0 to 65535	ms (s)	10	Im	Ru	P
H11-61	Waiting time after 10th displacement	0 to 10000	ms (s)	10	Im	Ru	P
H11-62	11th displacement	-1073741824 to 1073741824	Ref	10000	Im	Ru	P
H11-64	Maximum running speed of 11th displacement	1 to 6000	RPM	200	Im	Ru	P
H11-65	Acceleration/Deceleration time of 11th displacement	0 to 65535	ms (s)	10	Im	Ru	P
H11-66	Waiting time after 11th displacement	0 to 10000	ms (s)	10	Im	Ru	P
H11-67	12th displacement	-1073741824 to 1073741824	Ref	10000	Im	Ru	P
H11-69	Maximum running speed of 12th displacement	1 to 6000	RPM	200	Im	Ru	P
H11-70	Acceleration/Deceleration time of 12th displacement	0 to 65535	ms (s)	10	Im	Ru	P
H11-71	Waiting time after 12th displacement	0 to 10000	ms (s)	10	Im	Ru	P
H11-72	13th displacement	-1073741824 to 1073741824	Ref	10000	Im	Ru	P
H11-74	Maximum running speed of 13th displacement	1 to 6000	RPM	200	Im	Ru	P
H11-75	Acceleration/Deceleration time of 13th displacement	0 to 65535	ms (s)	10	Im	Ru	P
H11-76	Waiting time after 13th displacement	0 to 10000	ms (s)	10	Im	Ru	P
H11-77	14th displacement	-1073741824 to 1073741824	Ref	10000	Im	Ru	P
H11-79	Maximum running speed of 14th displacement	1 to 6000	RPM	200	Im	Ru	P
H11-80	Acceleration/Deceleration time of 14th displacement	0 to 65535	ms (s)	10	Im	Ru	P
H11-81	Waiting time after 14th displacement	0 to 10000	ms (s)	10	Im	Ru	P
H11-82	15th displacement	-1073741824 to 1073741824	Ref	10000	Im	Ru	P
H11-84	Maximum running speed of 15th displacement	1 to 6000	RPM	200	Im	Ru	P
H11-85	Acceleration/Deceleration time of 15th displacement	0 to 65535	ms (s)	10	Im	Ru	P
H11-86	Waiting time after 15th displacement	0 to 10000	ms (s)	10	Im	Ru	P
H11-87	16th displacement	-1073741824 to 1073741824	Ref	10000	Im	Ru	P
H11-89	Maximum running speed of 16th displacement	1 to 6000	RPM	200	Im	Ru	P

Function Code	Parameter Name	Setting Range	Unit	Default	ET	Pro	CM
H11-90	Acceleration/Deceleration time of 16th displacement	0 to 65535	ms (s)	10	Im	Ru	P
H11-91	Waiting time after 16th displacement	0 to 10000	ms (s)	10	Im	Ru	P

Group H12: Multi-Speed Function Parameters

Function Code	Parameter Name	Setting Range	Unit	Default	ET	Pro	CM
H12-00	Multi-speed running mode	0: Stop after running single cycle 1: Cyclic running 2: DI switchover	-	1	Im	St	S
H12-01	Number of speed reference profile	1 to 16	-	16	Im	St	S
H12-02	Time unit	0: sec; 1: min	-	0	Im	St	S
H12-03	Acceleration time 1	0 to 65535	ms	10	Im	St	S
H12-04	Deceleration time 1	0 to 65535	ms	10	Im	St	S
H12-05	Acceleration time 2	0 to 65535	ms	50	Im	St	S
H12-06	Deceleration time 2	0 to 65535	ms	50	Im	St	S
H12-07	Acceleration time 3	0 to 65535	ms	100	Im	St	S
H12-08	Deceleration time 3	0 to 65535	ms	100	Im	St	S
H12-09	Acceleration time 4	0 to 65535	ms	150	Im	St	S
H12-10	Deceleration time 4	0 to 65535	ms	150	Im	St	S
H12-20	1st speed reference	-6000 to 6000	RPM	0	Im	St	S
H12-21	Running time of 1st speed reference	0 to 6553.5	$\frac{s}{(min)}$	5.0	Im	St	S
H12-22	Acceleration/deceleration time of 1st speed reference	0: No acceleration/deceleration time 1: Acceleration/Deceleration time 1 2: Acceleration/Deceleration time 2 3: Acceleration/Deceleration time 3 4: Acceleration/Deceleration time 4	-	0	Im	St	S
H12-23	2nd speed reference	-6000 to 6000	RPM	100	Im	St	S
H12-24	Running time of 2nd speed reference	0 to 6553.5	$\frac{s}{(min)}$	5.0	Im	St	S
H12-25	Acceleration/deceleration time of 2nd speed reference	0: No acceleration/deceleration time 1: Acceleration/Deceleration time 1 2: Acceleration/Deceleration time 2 3: Acceleration/Deceleration time 3 4: Acceleration/Deceleration time 4	-	0	Im	St	S
H12-26	3rd speed reference	-6000 to 6000	RPM	300	Im	St	S
H12-27	Running time of 3rd speed reference	0 to 6553.5	$\frac{s}{(min)}$	5.0	Im	St	S
H12-28	Acceleration/deceleration time of 3rd speed reference	0: No acceleration/deceleration time 1: Acceleration/Deceleration time 1 2: Acceleration/Deceleration time 2 3: Acceleration/Deceleration time 3 4: Acceleration/Deceleration time 4	-	0	Im	St	S
H12-29	4th speed reference	-6000 to 6000	RPM	500	Im	St	S

6 Parameter Table

Function Code	Parameter Name	Setting Range	Unit	Default	ET	Pro	CM
H12-30	Running time of 4th speed reference	0 to 6553.5	s (min)	5.0	Im	St	S
H12-31	Acceleration/deceleration time of 4th speed reference	0: No acceleration/deceleration time 1: Acceleration/Deceleration time 1 2: Acceleration/Deceleration time 2 3: Acceleration/Deceleration time 3 4: Acceleration/Deceleration time 4	-	0	Im	St	S
H12-32	5th speed reference	-6000 to 6000	RPM	700	Im	St	S
H12-33	Running time of 5th speed reference	0 to 6553.5	s (min)	5.0	Im	St	S
H12-34	Acceleration/deceleration time of 5th speed reference	0: No acceleration/deceleration time 1: Acceleration/Deceleration time 1 2: Acceleration/Deceleration time 2 3: Acceleration/Deceleration time 3 4: Acceleration/Deceleration time 4	-	0	Im	St	S
H12-35	6th speed reference	-6000 to 6000	RPM	900	Im	St	S
H12-36	Running time of 6th speed reference	0 to 6553.5	s (min)	5.0	Im	St	S
H12-37	Acceleration/deceleration time of 6th speed reference	0: No acceleration/deceleration time 1: Acceleration/Deceleration time 1 2: Acceleration/Deceleration time 2 3: Acceleration/Deceleration time 3 4: Acceleration/Deceleration time 4	-	0	Im	St	S
H12-38	7th speed reference	-6000 to 6000	RPM	600	Im	St	S
H12-39	Running time of 7th speed reference	0 to 6553.5	s (min)	5.0	Im	St	S
H12-40	Acceleration/deceleration time of 7th speed reference	0: No acceleration/deceleration time 1: Acceleration/Deceleration time 1 2: Acceleration/Deceleration time 2 3: Acceleration/Deceleration time 3 4: Acceleration/Deceleration time 4	-	0	Im	St	S
H12-41	8th speed reference	-6000 to 6000	RPM	300	Im	St	S
H12-42	Running time of 8th speed reference	0 to 6553.5	s (min)	5.0	Im	St	S
H12-43	Acceleration/deceleration time of 8th speed reference	0: No acceleration/deceleration time 1: Acceleration/Deceleration time 1 2: Acceleration/Deceleration time 2 3: Acceleration/Deceleration time 3 4: Acceleration/Deceleration time 4	-	0	Im	St	S
H12-44	9th speed reference	-6000 to 6000	RPM	100	Im	St	S
H12-45	Running time of 9th speed reference	0 to 6553.5	s (min)	5.0	Im	St	S
H12-46	Acceleration/deceleration time of 9th speed reference	0: No acceleration/deceleration time 1: Acceleration/Deceleration time 1 2: Acceleration/Deceleration time 2 3: Acceleration/Deceleration time 3 4: Acceleration/Deceleration time 4	-	0	Im	St	S
H12-47	10th speed reference	-6000 to 6000	RPM	-100	Im	St	S
H12-48	Running time of 10th speed reference	0 to 6553.5	s (min)	5.0	Im	St	S

Function Code	Parameter Name	Setting Range	Unit	Default	ET	Pro	CM
H12-49	Acceleration/deceleration time of 10th speed reference	0: No acceleration/deceleration time 1: Acceleration/Deceleration time 1 2: Acceleration/Deceleration time 2 3: Acceleration/Deceleration time 3 4: Acceleration/Deceleration time 4	-	0	Im	St	S
H12-50	11th speed reference	-6000 to 6000	RPM	-300	Im	St	S
H12-51	Running time of 11th speed reference	0 to 6553.5	^s (min)	5.0	Im	St	S
H12-52	Acceleration/deceleration time of 11th speed reference	0: No acceleration/deceleration time 1: Acceleration/Deceleration time 1 2: Acceleration/Deceleration time 2 3: Acceleration/Deceleration time 3 4: Acceleration/Deceleration time 4	-	0	Im	St	S
H12-53	12th speed reference	-6000 to 6000	RPM	-500	Im	St	S
H12-54	Running time of 12th speed reference	0 to 6553.5	^s (min)	5.0	Im	St	S
H12-55	Acceleration/deceleration time of 12th speed reference	0: No acceleration/deceleration time 1: Acceleration/Deceleration time 1 2: Acceleration/Deceleration time 2 3: Acceleration/Deceleration time 3 4: Acceleration/Deceleration time 4	-	0	Im	St	S
H12-56	13th speed reference	-6000 to 6000	RPM	-700	Im	St	S
H12-57	Running time of 13th speed reference	0 to 6553.5	^s (min)	5.0	Im	St	S
H12-58	Acceleration/deceleration time of 13th speed reference	0: No acceleration/deceleration time 1: Acceleration/Deceleration time 1 2: Acceleration/Deceleration time 2 3: Acceleration/Deceleration time 3 4: Acceleration/Deceleration time 4	-	0	Im	St	S
H12-59	14th speed reference	-6000 to 6000	RPM	-900	Im	St	S
H12-60	Running time of 14th speed reference	0 to 6553.5	^s (min)	5.0	Im	St	S
H12-61	Acceleration/deceleration time of 14th speed reference	0: No acceleration/deceleration time 1: Acceleration/Deceleration time 1 2: Acceleration/Deceleration time 2 3: Acceleration/Deceleration time 3 4: Acceleration/Deceleration time 4	-	0	Im	St	S
H12-62	15th speed reference	-6000 to 6000	RPM	-600	Im	St	S
H12-63	Running time of 15th speed reference	0 to 6553.5	^s (min)	5.0	Im	St	S
H12-64	Acceleration/deceleration time of 15th speed reference	0: No acceleration/deceleration time 1: Acceleration/Deceleration time 1 2: Acceleration/Deceleration time 2 3: Acceleration/Deceleration time 3 4: Acceleration/Deceleration time 4	-	0	Im	St	S
H12-65	16th speed reference	-6000 to 6000	RPM	-300	Im	St	S
H12-66	Running time of 16th speed reference	0 to 6553.5	^s (min)	5.0	Im	St	S

Function Code	Parameter Name	Setting Range	Unit	Default	ET	Pro	CM
H12-67	Acceleration/deceleration time of 16th speed reference	0: No acceleration/deceleration time 1: Acceleration/Deceleration time 1 2: Acceleration/Deceleration time 2 3: Acceleration/Deceleration time 3 4: Acceleration/Deceleration time 4	-	0	Im	St	S

Group H17: VDI/VDO Parameters

Function Code	Parameter Name	Setting Range	Unit	Default	ET	Pro	CM
H17-00	VDI1 function selection	0 to 37	-	0	St	Ru	-
H17-01	VDI1 logic selection	0: Valid when logic is 1 1: Valid when logic changes from 0 to 1	-	0	St	Ru	-
H17-02	VDI2 function selection	0 to 37	-	0	St	Ru	-
H17-03	VDI2 logic selection	0: Valid when logic is 1 1: Valid when logic changes from 0 to 1	-	0	St	Ru	-
H17-04	VDI3 function selection	0 to 37	-	0	St	Ru	-
H17-05	VDI3 logic selection	0: Valid when logic is 1 1: Valid when logic changes from 0 to 1	-	0	St	Ru	-
H17-06	VDI4 function selection	0 to 37	-	0	St	Ru	-
H17-07	VDI4 logic selection	0: Valid when logic is 1 1: Valid when logic changes from 0 to 1	-	0	St	Ru	-
H17-08	VDI5 function selection	0 to 37	-	0	St	Ru	-
H17-09	VDI5 logic selection	0: Valid when logic is 1 1: Valid when logic changes from 0 to 1	-	0	St	Ru	-
H17-10	VDI6 function selection	0 to 37	-	0	St	Ru	-
H17-11	VDI6 logic selection	0: Valid when logic is 1 1: Valid when logic changes from 0 to 1	-	0	St	Ru	-
H17-12	VDI7 function selection	0 to 37	-	0	St	Ru	-
H17-13	VDI7 logic selection	0: Valid when logic is 1 1: Valid when logic changes from 0 to 1	-	0	St	Ru	-
H17-14	VDI8 function selection	0 to 37	-	0	St	Ru	-
H17-15	VDI8 logic selection	0: Valid when logic is 1 1: Valid when logic changes from 0 to 1	-	0	St	Ru	-
H17-16	VDI9 function selection	0 to 37	-	0	St	Ru	-
H17-17	VDI9 logic selection	0: Valid when logic is 1 1: Valid when logic changes from 0 to 1	-	0	St	Ru	-
H17-18	VDI10 function selection	0 to 37	-	0	St	Ru	-
H17-19	VDI10 logic selection	0: Valid when logic is 1 1: Valid when logic changes from 0 to 1	-	0	St	Ru	-
H17-20	VDI11 function selection	0 to 37	-	0	St	Ru	-
H17-21	VDI11 logic selection	0: Valid when logic is 1 1: Valid when logic changes from 0 to 1	-	0	St	Ru	-
H17-22	VDI12 function selection	0 to 37	-	0	St	Ru	-

Function Code	Parameter Name	Setting Range	Unit	Default	ET	Pro	CM
H17-23	VDI12 logic selection	0: Valid when logic is 1 1: Valid when logic changes from 0 to 1	-	0	St	Ru	-
H17-24	VDI13 function selection	0 to 37	-	0	St	Ru	-
H17-25	VDI13 logic selection	0: Valid when logic is 1 1: Valid when logic changes from 0 to 1	-	0	St	Ru	-
H17-26	VDI14 function selection	0 to 37	-	0	St	Ru	-
H17-27	VDI14 logic selection	0: Valid when logic is 1 1: Valid when logic changes from 0 to 1	-	0	St	Ru	-
H17-28	VDI15 function selection	0 to 37	-	0	St	Ru	-
H17-29	VDI15 logic selection	0: Valid when logic is 1 1: Valid when logic changes from 0 to 1	-	0	St	Ru	-
H17-30	VDI16 function selection	0 to 37	-	0	St	Ru	-
H17-31	VDI16 logic selection	0: Valid when logic is 1 1: Valid when logic changes from 0 to 1	-	0	St	Ru	-
H17-32	VDO virtual level	-	-	-	-	D	-
H17-33	VDO1 function selection	0 to 22	-	0	St	Ru	-
H17-34	VDO1 logic selection	0: Output 1 when function valid 1: Output 0 when function valid	-	0	St	Ru	-
H17-35	VDO2 function selection	0 to 22	-	0	St	Ru	-
H17-36	VDO2 logic selection	0: Output 1 when function valid 1: Output 0 when function valid	-	0	St	Ru	-
H17-37	VDO3 function selection	0 to 22	-	0	St	Ru	-
H17-38	VDO3 logic selection	0: Output 1 when function valid 1: Output 0 when function valid	-	0	St	Ru	-
H17-39	VDO4 function selection	0 to 22	-	0	St	Ru	-
H17-40	VDO4 logic selection	0: Output 1 when function valid 1: Output 0 when function valid	-	0	St	Ru	-
H17-41	VDO5 function selection	0 to 22	-	0	St	Ru	-
H17-42	VDO5 logic selection	0: Output 1 when function valid 1: Output 0 when function valid	-	0	St	Ru	-
H17-43	VDO6 function selection	0 to 22	-	0	St	Ru	-
H17-44	VDO6 logic selection	0: Output 1 when function valid 1: Output 0 when function valid	-	0	St	Ru	-
H17-45	VDO7 function selection	0 to 22	-	0	St	Ru	-
H17-46	VDO7 logic selection	0: Output 1 when function valid 1: Output 0 when function valid	-	0	St	Ru	-
H17-47	VDO8 function selection	0 to 22	-	0	St	Ru	-
H17-48	VDO8 logic selection	0: Output 1 when function valid 1: Output 0 when function valid	-	0	St	Ru	-
H17-49	VDO9 function selection	0 to 22	-	0	St	Ru	-
H17-50	VDO9 logic selection	0: Output 1 when function valid 1: Output 0 when function valid	-	0	St	Ru	-
H17-51	VDO10 function selection	0 to 22	-	0	St	Ru	-
H17-52	VDO10 logic selection	0: Output 1 when function valid 1: Output 0 when function valid	-	0	St	Ru	-

Function Code	Parameter Name	Setting Range	Unit	Default	ET	Pro	CM
H17-53	VDO11 function selection	0 to 22	-	0	St	Ru	-
H17-54	VDO11 logic selection	0: Output 1 when function valid 1: Output 0 when function valid	-	0	St	Ru	-
H17-55	VDO12 function selection	0 to 22	-	0	St	Ru	-
H17-56	VDO12 logic selection	0: Output 1 when function valid 1: Output 0 when function valid	-	0	St	Ru	-
H17-57	VDO13 function selection	0 to 22	-	0	St	Ru	-
H17-58	VDO13 logic selection	0: Output 1 when function valid 1: Output 0 when function valid	-	0	St	Ru	-
H17-59	VDO14 function selection	0 to 22	-	0	St	Ru	-
H17-60	VDO14 logic selection	0: Output 1 when function valid 1: Output 0 when function valid	-	0	St	Ru	-
H17-61	VDO15 function selection	0 to 22	-	0	St	Ru	-
H17-62	VDO15 logic selection	0: Output 1 when function valid 1: Output 0 when function valid	-	0	St	Ru	-
H17-63	VDO16 function selection	0 to 22	-	0	St	Ru	-
H17-64	VDO16 logic selection	0: Output 1 when function valid 1: Output 0 when function valid	-	0	St	Ru	-

Group H30: Servo Variables Read via Communication

(Invisible on operation panel)

Function Code	Parameter Name	Setting Range	Unit	Default	ET	Pro	CM
H30-00	Servo state read via communication	-	-	-	-	Dp	PST
H30-01	DO function state 1 read via communication	-	-	-	-	Dp	PST
H30-02	DO function state 2 read via communication	-	-	-	-	Dp	PST
H30-03	Input pulse signal sampling read via communication	-	-	-	-	D	PST

Group H31: Servo Variables Set via Communication

(Invisible on operation panel)

Function Code	Parameter Name	Setting Range	Unit	Default	ET	Pro	CM
H31-00	VDI virtual level set via communication	0 to 65535	-	0	Im	Ru	PST
H31-04	DO state set via communication	0 to 31	-	0	Im	Ru	PST
H31-09	Speed reference set via communication	-6000.000 to 6000.000	RPM	0	Im	Ru	S
H31-11	Torque reference set via communication	-100.000 to 100.000	%	0	Im	Ru	T

DI/DO Function Definitions

No.	Function Symbol	Function Name	Description	Remarks
Input Function Description				
FunIN.1	S-ON	Servo ON	Invalid: Servo motor disabled Valid: Servo motor enabled	The logic of the corresponding terminal needs to be set to level valid. The change of the corresponding DI or VDI or terminal logic takes effect only after power-on again.
FunIN.2	ALM-RST	Fault and warning reset (edge valid)	Invalid: Disabled Valid: Enabled	This DI function is edge valid rather than high/low level valid. The servo drive can continue to operate after fault/warning reset. When this function is allocated to a low-speed DI and logic of the DI is level valid, the servo drive will forcibly changes it to edge logic. The valid level change must last for more than 3 ms; otherwise, the fault reset function becomes invalid. Do not allocate this function to high-speed DI. Otherwise, fault/warning reset will be invalid.
FunIN.3	GAIN-SEL	Gain switchover	H08-09 = 1: Invalid: Speed control loop being PI control Invalid: Speed control loop being P control H08-09 = 2: Invalid: Fixed at 1st gain Valid: Fixed at 2nd gain	It is recommended that the logic of the corresponding terminal be set to level valid.
FunIN.4	CMD-SEL	Main/Auxiliary reference switchover	Valid: Current running reference being A Invalid: Current running reference being B	It is recommended that the logic of the corresponding terminal be set to level valid.
FunIN.5	DIR-SEL	Multi-reference direction	Invalid: Default reference direction Valid: Reverse to reference direction	It is recommended that the logic of the corresponding terminal be set to level valid.
FunIN.6	CMD1	Multi-reference switchover 1	Used to select one from the 16 references	It is recommended that the logic of the corresponding terminal be set to level valid.

No.	Function Symbol	Function Name	Description	Remarks
FunIN.7	CMD2	Multi-reference switchover 2	Used to select one from the 16 references	It is recommended that the logic of the corresponding terminal be set to level valid.
FunIN.8	CMD3	Multi-reference switchover 3	Used to select one from the 16 references	It is recommended that the logic of the corresponding terminal be set to level valid.
FunIN.9	CMD4	Multi-reference switchover 4	Used to select one from the 16 references	It is recommended that the logic of the corresponding terminal be set to level valid.
FunIN.10	M1-SEL	Mode switchover 1	Used to perform switchover between speed control, position control, and torque control based on the selected control mode (H02-00 = 3/4/5).	It is recommended that the logic of the corresponding terminal be set to level valid.
FunIN.11	M2-SEL	Mode switchover 2	Used to perform switchover between speed control, position control, and torque control based on the selected control mode (H02-00 = 6).	It is recommended that the logic of the corresponding terminal be set to level valid.
FunIN.12	ZCLAMP	Zero speed clamp	Valid: Zero speed clamp enabled Invalid: Zero speed clamp disabled	It is recommended that the logic of the corresponding terminal be set to level valid.
FunIN.13	INHIBIT	Position reference inhibited	Invalid: The servo drive responds to position references in position control mode. Valid: The servo drive does not respond to any internal or external position reference in position control mode.	The position references include internal and external position references. It is recommended that the logic of the corresponding terminal be set to level valid.
FunIN.14	P-OT	Forward limit switch	Valid: Forward drive inhibited Invalid: Forward drive permitted	When the mechanical movement is outside the movable range, the servo drive implements the function of preventing the motor from sensing the limit switch.
FunIN.15	N-OT	Reverse limit switch	Valid: Reverse drive inhibited Invalid: Reverse drive permitted	It is recommended that the logic of the corresponding terminal be set to level valid.

No.	Function Symbol	Function Name	Description	Remarks
FunIN.16	P-CL	External positive torque limit	<p>The torque limit source is switched over based on the setting of H07-07.</p> <p>H07-07 = 1: Valid: External positive torque limit enabled Invalid: Internal positive torque limit enabled</p> <p>H07-07 = 3 and AI limit larger than external positive limit Valid: External positive torque limit enabled Invalid: AI torque limit enabled</p> <p>H07-07 = 4: Valid: AI torque limit enabled Invalid: Internal positive torque limit enabled</p>	It is recommended that the logic of the corresponding terminal be set to level valid.
FunIN.17	N-CL	External negative torque limit	<p>The torque limit source is switched over based on the setting of H07-07.</p> <p>H07-07 = 1: Valid: External negative torque limit enabled Invalid: Internal negative torque limit enabled</p> <p>H07-07 = 3 and AI limit larger than external negative limit Valid: External negative torque limit enabled Invalid: AI torque limit enabled</p> <p>H07-07 = 4: Valid: AI torque limit enabled Invalid: Internal negative torque limit enabled</p>	It is recommended that the logic of the corresponding terminal be set to level valid.
FunIN.18	JOGCMD+	Forward jog	<p>Valid: Execute reference input Invalid: Not receive reference input</p>	It is recommended that the logic of the corresponding terminal be set to level valid.
FunIN.19	JOGCMD-	Reverse jog	<p>Valid: Input reverse to reference direction Invalid: Reference input stopped</p>	It is recommended that the logic of the corresponding terminal be set to level valid.
FunIN.20	POSSTEP	Step reference	<p>In servo running state Valid: Execute step reference set in H05-05, servo motor running Invalid: Servo motor in locked state</p>	It is recommended that the logic of the corresponding terminal be set to level valid.

No.	Function Symbol	Function Name	Description	Remarks
FunIN.21	HX1	Handwheel multiplying factor signal 1	HX1 valid, HX2 invalid: X10 HX1 invalid, HX2 valid: X100 Other: X1	It is recommended that the logic of the corresponding terminal be set to level valid.
FunIN.22	HX2	Handwheel multiplying factor signal 2		
FunIN.23	HX_EN	Handwheel signal	Invalid: Handwheel disabled Valid: Handwheel enabled	It is recommended that the logic of the corresponding terminal be set to level valid.
FunIN.24	GEAR_SEL	Electronic gear ratio switchover	Invalid: Electronic gear ratio 1 Valid: Electronic gear ratio 2	It is recommended that the logic of the corresponding terminal be set to level valid.
FunIN.25	TOQDirSel	Torque reference direction selection	Valid: Forward direction Invalid: Reverse direction	It is recommended that the logic of the corresponding terminal be set to level valid.
FunIN.26	SPDDirSel	Speed reference direction selection	Valid: Forward direction Invalid: Reverse direction	It is recommended that the logic of the corresponding terminal be set to level valid.
FunIN.27	POSDirSel	Position reference direction selection	Valid: Actual position reference direction same as given position reference direction Invalid: Actual position reference direction opposite to given position reference direction	It is recommended that the logic of the corresponding terminal be set to level valid.
FunIN.28	PosInSen	Multi-position reference enable (edge valid)	Invalid: Disabled, servo motor in locked state Valid: Enabled	It is recommended that the logic of the corresponding terminal be set to level valid.
FunIN.29	XintFree	Position change on fly unlock	Valid: The position change on fly state is unlocked, and the servo drive can respond to other position references. Invalid: The position change on fly signal is retained, and the servo drive does not respond to other position references.	It is recommended that the logic of the corresponding terminal be set to edge valid.

No.	Function Symbol	Function Name	Description	Remarks
FunIN.31	HomeSwitch	Home switch	Invalid: Not triggered Valid: Triggered, current position being home	The logic of the corresponding terminal needs to be set to level valid. Allocate this function to the high-speed DI terminal. If the logic is set to 2 (rising edge valid), the servo drive forcibly changes it to 1 (high level valid). If the logic is set to 3 (falling edge valid), the servo drive forcibly changes it to 0 (low level valid). If the logic is set to 4 (both rising edge and falling edge valid), the servo drive forcibly changes it to 0 (low level valid).
FunIN.32	HomingStart	Homing function	Valid: Enabled (the function cannot be enabled repeatedly when running) Invalid: Disabled	It is recommended that the logic of the corresponding terminal be set to edge valid.
FunIN.33	XintInhibit	Position change on fly inhibited	Valid: Position change on fly inhibited Invalid: Position change on fly permitted	The logic of the corresponding terminal needs to be set to level valid. If the logic is set to 2 (rising edge valid), the servo drive forcibly changes it to 1 (high level valid). If the logic is set to 3 (falling edge valid), the servo drive forcibly changes it to 0 (low level valid). If the logic is set to 4 (both rising edge and falling edge valid), the servo drive forcibly changes it to 0 (low level valid).
FunIN.34	EmergencyStop	Emergency stop	Valid: Position lock after emergency stop Invalid: Current running state unaffected	It is recommended that the logic of the corresponding terminal be set to level valid.
FunIN.35	ClrPosErr	Position deviation cleared	Valid: Position deviation cleared Invalid: Position deviation not cleared	It is recommended that the logic of the corresponding terminal be set to edge valid. It is recommended that this function be allocated to DI8 or DI9.
FunIN.36	V_LmtSel	Internal speed limit source	Valid: H07-20 as internal speed limit (H07-17 = 2) Valid: H07-19 as internal speed limit (H07-17 = 2)	It is recommended that the logic of the corresponding terminal be set to level valid.

No.	Function Symbol	Function Name	Description	Remarks
FunIN.37	PulseInhibit	Pulse input inhibited	When the position reference source is pulse input (H05-00 = 0) in the position control mode: Invalid: Respond to pulse input Valid: Not respond to pulse input	It is recommended that the logic of the corresponding terminal be set to level valid.
Output Function Description				
FunOUT.1	S-RDY	Servo ready	The servo drive is in ready state and can receive the S-ON signal. Valid: Servo drive ready Invalid: Servo drive not ready	Servo not ready: A No. 1 or 2 fault occurs in the servo drive, or the DI emergency stop signal is active.
FunOUT.2	TGON	Motor rotation output	Valid: Motor speed absolute value after filter smaller than H06-16 Invalid: Motor speed absolute value after filter equal to or larger than H06-16	-
FunOUT.3	ZERO	Zero speed signal	Invalid: The absolute deviation between the motor speed feedback and the speed reference is larger than the setting of H06-19. Valid: The absolute deviation between the motor speed feedback and the speed reference is smaller than or equal to the setting of H06-19.	-
FunOUT.4	V-CMP	Speed consistent	In the speed control mode, when the absolute value of the deviation between the motor speed and the speed reference is smaller than the value of H06-17, this signal is active.	-
FunOUT.5	COIN	Positioning completed	In the position control mode, when the position deviation pulses reach the value of H05-21, this signal is active.	-
FunOUT.6	NEAR	Positioning near	In the position control mode, when the position deviation pulses reach the value of H05-22, this signal is active.	-
FunOUT.7	C-LT	Torque limit	Confirming torque limit: Valid: Motor torque limited Invalid: Motor torque not limited	-

No.	Function Symbol	Function Name	Description	Remarks
FunOUT.8	V-LT	Speed limit	Confirming speed limit in torque control: Invalid: Motor speed not reaching the speed limit Valid: Motor speed reaching the speed limit and speed loop built internally based on the speed limit	-
FunOUT.9	BK	Brake output	Brake output: Invalid: The power is on, the brake is applied, and the motor is in position lock state. Valid: The power is off, the brake is released, and the motor can rotate.	-
FunOUT.10	WARN	Warning output	The warning output is active (conducted).	-
FunOUT.11	ALM	Fault output	This signal is valid when a fault occurs.	-
FunOUT.12	ALMO1	3-digit fault code output	A 3-digit fault code is output.	-
FunOUT.13	ALMO2	3-digit fault code output	A 3-digit fault code is output.	-
FunOUT.14	ALMO3	3-digit fault code output	A 3-digit fault code is output.	-
FunOUT.15	Xintcoin	Position change on fly completed	Valid: Position change on fly completed Invalid: Position change on fly not completed	-
FunOUT.16	HomeAttain	Home attaining output	Home attaining state: Valid: Home attaining completed Invalid: Home attaining not completed	-
FunOUT.17	ElecHomeAttain	Electrical home attaining output	Electric home attaining state: Valid: Electrical home attaining completed Invalid: Electrical home attaining not completed	-
FunOUT.18	ToqReach	Torque reached	Valid: Absolute value of torque reference reaching setting value Invalid: Absolute value of torque reference smaller than setting value	-
FunOUT.19	V-Arr	Speed reached	Valid: Speed feedback reaches setting value Invalid: Speed feedback smaller than setting value	-

6 Parameter Table

No.	Function Symbol	Function Name	Description	Remarks
FunOUT.20	AngIntRdy	Angle auto-tuning output	Valid: Angle auto-tuning completed Invalid: Angle auto-tuning not completed	-
FunOUT.21	DB	DB braking output	Valid: Dynamic braking relay open Invalid: Dynamic braking relay close	-
FunOUT.22	CmdOk	Internal reference output	Valid: Internal reference completed Invalid: Internal reference not completed	-

Revision History

Date	Version	Change Description
March 2016	A00	First issue.
Dec 2016	A01	Modified product name, designation rule and nameplate.
Oct 2018	A02	Updated LOGO.
July 2019	A03	Added with a barcode on the back cover

Shenzhen Inovance Technology Co., Ltd.

Add.: Building E, Hongwei Industry Park, Liuxian Road, Baocheng No. 70 Zone, Bao'an District, Shenzhen

Tel: +86-755-2979 9595

Fax: +86-755-2961 9897

Service Hotline: 400-777-1260

<http://www.inovance.com>

Suzhou Inovance Technology Co., Ltd.

Add.: No. 16 Youxiang Road, Yuexi Town, Wuzhong District, Suzhou 215104, P.R. China

Tel: +86-512-6637 6666

Fax: +86-512-6285 6720

Service Hotline: 400-777-1260

<http://www.inovance.com>



19010417A03

Copyright © Shenzhen Inovance Technology Co., Ltd.